



# HP EliteBook 820 G1 Notebook PC and HP EliteBook 725 G2 Notebook PC

Maintenance and Service Guide

© Copyright 2014 Hewlett-Packard  
Development Company, L.P.

AMD, the AMD Arrow logo, and combinations thereof, are trademarks of Advanced Micro Devices, Inc. Bluetooth is a trademark owned by its proprietor and used by Hewlett-Packard Company under license. Intel and Core are trademarks of Intel Corporation in the U.S. and other countries. Microsoft and Windows are U.S. registered trademarks of Microsoft Corporation. SD Logo is a trademark of its proprietor.

The information contained herein is subject to change without notice. The only warranties for HP products and services are set forth in the express warranty statements accompanying such products and services. Nothing herein should be construed as constituting an additional warranty. HP shall not be liable for technical or editorial errors or omissions contained herein.

Third Edition: May 2014

Second Edition: March 2014

First Edition: September 2013

Document Part Number: 723686-003

### **Product notice**

This guide describes features that are common to most models. Some features may not be available on your computer.

Not all features are available in all editions of Windows 8. This computer may require upgraded and/or separately purchased hardware, drivers, and/or software to take full advantage of Windows 8 functionality. See <http://www.microsoft.com> for details.

### **Software terms**

By installing, copying, downloading, or otherwise using any software product preinstalled on this computer, you agree to be bound by the terms of the HP End User License Agreement (EULA). If you do not accept these license terms, your sole remedy is to return the entire unused product (hardware and software) within 14 days for a refund subject to the refund policy of your place of purchase.

For any further information or to request a full refund of the computer, please contact your local point of sale (the seller).

## Safety warning notice

---

**⚠ WARNING!** To reduce the possibility of heat-related injuries or of overheating the device, do not place the device directly on your lap or obstruct the device air vents. Use the device only on a hard, flat surface. Do not allow another hard surface, such as an adjoining optional printer, or a soft surface, such as pillows or rugs or clothing, to block airflow. Also, do not allow the AC adapter to contact the skin or a soft surface, such as pillows or rugs or clothing, during operation. The device and the AC adapter comply with the user-accessible surface temperature limits defined by the International Standard for Safety of Information Technology Equipment (IEC 60950).

---



---

# Table of contents

<b>1 Product description .....</b>	<b>1</b>
Product Name .....	1
Chipset .....	1
Processor .....	2
Panel .....	3
Graphics .....	3
Memory .....	4
Flash cache .....	4
MiniCard solid-state drive .....	4
Primary storage .....	5
Audio and video .....	6
Ethernet .....	7
Wireless networking .....	7
External expansion .....	8
Ports .....	9
Docking .....	9
Keyboard/pointing devices .....	9
Power requirements .....	10
Security .....	10
Operating system .....	11
Serviceability .....	15
<b>2 External component identification .....</b>	<b>17</b>
Display .....	17
Buttons and fingerprint reader (select models only) .....	19
Keys .....	20
Lights .....	21
TouchPad .....	22
Front .....	23
Left side .....	24
Right side .....	25

Bottom .....	26
<b>3 Illustrated parts catalog .....</b>	<b>27</b>
Locating the serial number, product number, and model number .....	27
Computer major components .....	29
Display assembly components .....	41
Plastics Kit .....	43
Mass storage devices .....	44
Miscellaneous parts .....	45
Sequential part number listing .....	48
<b>4 Removal and replacement preliminary requirements .....</b>	<b>65</b>
Tools required .....	65
Service considerations .....	65
Plastic parts .....	65
Cables and connectors .....	66
Drive handling .....	66
Grounding guidelines .....	67
Electrostatic discharge damage .....	67
Packaging and transporting guidelines .....	68
Workstation guidelines .....	68
<b>5 Removal and replacement procedures for Customer Self-Repair parts .....</b>	<b>71</b>
Component replacement procedures .....	71
Service cover .....	71
Battery .....	73
Hard drive .....	75
WWAN module .....	78
Solid-state drive .....	80
WLAN module .....	82
Memory module .....	84
Keyboard .....	85
<b>6 Removal and replacement procedures for Authorized Service Provider parts .....</b>	<b>93</b>
Component replacement procedures .....	93
RTC battery .....	93
Top cover .....	94
Display assembly .....	98
TouchPad .....	107
Card reader board .....	108

Heat sink .....	111
Fan .....	113
System board .....	115
Fingerprint reader board .....	121
Speaker assembly .....	122
Power button board .....	124

## **7 Computer Setup (BIOS) ..... 127**

Windows 8 – Computer Setup (BIOS), MultiBoot, and HP PC Hardware Diagnostics (UEFI) .....	127
Using Computer Setup .....	127
Starting Computer Setup .....	127
Navigating and selecting in Computer Setup .....	128
Restoring factory settings in Computer Setup .....	129
Updating the BIOS .....	129
Determining a BIOS version .....	129
Downloading a BIOS update for Windows 8 .....	130
Using MultiBoot .....	131
About the boot device order .....	131
Choosing MultiBoot preferences .....	131
Setting a new boot order in Computer Setup .....	131
Dynamically choosing a boot device using the f9 prompt .....	132
Setting a MultiBoot Express prompt .....	132
Entering MultiBoot Express preferences .....	133
Using HP PC Hardware Diagnostics (UEFI) (select models only) .....	133
Downloading HP PC Hardware Diagnostics (UEFI) to a USB device .....	134
Windows 7 – Computer Setup (BIOS), MultiBoot, and HP PC Hardware Diagnostics (UEFI) .....	135
Using Computer Setup .....	135
Starting Computer Setup .....	135
Navigating and selecting in Computer Setup .....	135
Restoring factory settings in Computer Setup .....	136
Updating the BIOS .....	137
Determining a BIOS version .....	137
Downloading a BIOS update for Windows 7 .....	138
Using MultiBoot .....	139
About the boot device order .....	139
Choosing MultiBoot preferences .....	139
Setting a new boot order in Computer Setup .....	139
Dynamically choosing a boot device using the f9 prompt .....	140
Setting a MultiBoot Express prompt .....	140
Entering MultiBoot Express preferences .....	141
Using HP PC Hardware Diagnostics (UEFI) (select models only) .....	141

Downloading HP PC Hardware Diagnostics (UEFI) to a USB device .....	142
Linux – Computer Setup (BIOS) and Advanced System Diagnostics .....	143
Starting Computer Setup .....	143
Using Computer Setup .....	143
Navigating and selecting in Computer Setup .....	143
Restoring factory settings in Computer Setup .....	144
Updating the BIOS .....	145
Determining the BIOS version .....	145
Downloading a BIOS update .....	145
Using Advanced System Diagnostics .....	146

## **8 Specifications ..... 147**

## **9 Backup and recovery ..... 149**

Windows 8 .....	149
Backing up your information .....	149
Performing a system recovery .....	150
Using the Windows recovery tools .....	151
Using f11 recovery tools .....	152
Using Windows 8 operating system media (purchased separately) .....	152
Using Windows Refresh for quick and easy recovery .....	153
Remove everything and reinstall Windows .....	153
Using HP Software Setup .....	154
Windows 7 .....	155
Creating recovery media with HP Recovery Disc Creator .....	156
Creating recovery media .....	156
Backing up your information .....	156
Performing a system recovery .....	157
Using the Windows recovery tools .....	158
Using f11 recovery tools .....	159
Using a Windows 7 operating system DVD (purchased separately) .....	160
Linux .....	161
Creating backups .....	161
Backing up your information .....	161
Performing a system recovery .....	162
Remove everything and reinstall SLED .....	163

## **10 Statement of Volatility ..... 165**

Non-volatile memory usage .....	167
Questions and answers .....	171



Using HP Sure Start (select models only) .....	172
<b>11 Power cord set requirements .....</b>	<b>173</b>
Requirements for all countries .....	173
Requirements for specific countries and regions .....	173
<b>12 Recycling .....</b>	<b>175</b>
<b>Index .....</b>	<b>177</b>



---

# 1 Product description

## Product Name

Description	HP EliteBook 725 G2 Notebook PC	HP EliteBook 820 G1 Notebook PC
HP EliteBook 725 G2 Notebook PC	×	
HP EliteBook 820 G1 Notebook PC		×

## Chipset

Description	HP EliteBook 725 G2 Notebook PC	HP EliteBook 820 G1 Notebook PC
AMD® A76M fusion controller hub (FCH)	×	
Intel® processor controller hub (PCH), soldered on circuit (SoC)		×

# Processor

Description	HP EliteBook 725 G2 Notebook PC	HP EliteBook 820 G1 Notebook PC
<ul style="list-style-type: none"> <li>• AMD A10 Pro-7350B 2.10-GHz (SC turbo up to 3.30-GHz) quad core processor (4.00-MB L2 cache, 19 W)</li> </ul>	×	
<ul style="list-style-type: none"> <li>• AMD A8 Pro-7150B 2.00-GHz (SC turbo up to 3.20-GHz) quad core processor (4.00-MB L2 cache, 19 W)</li> </ul>		
<ul style="list-style-type: none"> <li>• AMD A6 Pro-7050B 2.20-GHz (SC turbo up to 3.00-GHz) dual core processor (1.00-MB L2 cache, 17 W)</li> </ul>		
<ul style="list-style-type: none"> <li>• Intel Core® i7-4600U 2.10-GHz (SC turbo up to 3.30-GHz) processor (4.00-MB L3 cache, 15 W)</li> </ul>		×
<ul style="list-style-type: none"> <li>• Intel Core i7-4510U 2.00-GHz (SC turbo up to 3.10-GHz) processor (4.00-MB L3 cache, 15 W)</li> </ul>		
<ul style="list-style-type: none"> <li>• Intel Core i7-4500U 1.80-GHz (SC turbo up to 3.00-GHz) processor (4.00-MB L3 cache, 15 W)</li> </ul>		
<ul style="list-style-type: none"> <li>• Intel Core i5-4310U 2.00-GHz (SC turbo up to 3.00-GHz) processor (3.00-MB L3 cache, 15 W)</li> </ul>		
<ul style="list-style-type: none"> <li>• Intel Core i5-4300U 1.90-GHz (SC turbo up to 2.90-GHz) processor (3.00-MB L3 cache, 15 W)</li> </ul>		
<ul style="list-style-type: none"> <li>• Intel Core i5-4210U 1.70-GHz (SC turbo up to 2.70-GHz) processor (3.00-MB L3 cache, 15 W)</li> </ul>		
<ul style="list-style-type: none"> <li>• Intel Core i5-4200U 1.60-GHz (SC turbo up to 2.60-GHz) processor (3.00-MB L3 cache, 15 W)</li> </ul>		
<ul style="list-style-type: none"> <li>• Intel Core i3-4030U 1.90-GHz processor (3.00-MB L3 cache, 15 W)</li> </ul>		
<ul style="list-style-type: none"> <li>• Intel Core i3-4010U 1.70-GHz processor (3.00-MB L3 cache, 15 W)</li> </ul>		

# Panel

Description	HP EliteBook 725 G2 Notebook PC	HP EliteBook 820 G1 Notebook PC
<ul style="list-style-type: none"> <li>12.5-in, Premium AntiGlare (AG), full high-definition (FHD), light-emitting diode (LED), 1920×1080, UWVA, typical brightness: 300 nits, ultraslim (1.2-mm), 50% CG, eDP display panel with and without webcam</li> </ul>	×	
<ul style="list-style-type: none"> <li>12.5-in, AG, HD, LED, 1366×768, SVA, typical brightness: 200 nits, ultraslim (1.2-mm), 45% CG, eDP display panel with and without webcam</li> </ul>		
<ul style="list-style-type: none"> <li>12.5-in, Premium AntiGlare (AG), high-definition HD, light-emitting diode (LED), 1366×768, UWVA, typical brightness: 300 nits, ultraslim (1.2-mm), 50% CG, eDP display panel with and without webcam</li> </ul>		×
<ul style="list-style-type: none"> <li>12.5-in, AG, HD, LED, 1366×768, SVA, typical brightness: 200 nits, ultraslim (1.2-mm), 45% CG, eDP display panel with and without webcam</li> </ul>		

# Graphics

Description	HP EliteBook 725 G2 Notebook PC	HP EliteBook 820 G1 Notebook PC
<p>AMD Graphics: Radeon® R6 Graphics on computer models equipped with an A10 Pro-7350B processor; Radeon R5 Graphics on computer models equipped with an A8 Pro-7150B processor; Radeon R4 Graphics on computer models equipped with an A6 Pro-7050B processor</p> <p>Universal memory architecture (UMA) graphics</p> <p>Support for dual-display ports through the HP 2013 UltraSlim Docking Station</p> <p>Support for up to 3 displays through the HP 2013 UltraSlim Docking Station</p>	×	
<p>Intel Graphics: Intel HD Graphics 4400</p> <p>UMA graphics</p> <p>Support for up to 3 displays through the HP 2013 UltraSlim Docking Station</p>		×

# Memory

Description	HP EliteBook 725 G2 Notebook PC	HP EliteBook 820 G1 Notebook PC
Two customer-accessible/upgradable memory module slots	×	×
Support for DDR3L 1600-MHz PCL3-12800 dual channel memory		
Support for 16384-MB of system memory in the following configurations:		
<ul style="list-style-type: none"><li>16384-MB total system memory (8192 MB × 2; not available with Windows 7 32-bit operating system, available with Windows 7 downgrade)</li><li>12288-MB total system memory (8192 MB + 4096 MB)</li><li>8192-MB total system memory (4096 MB × 2 or 8192 MB × 1; not available with Windows 7 32-bit operating system, available with Windows 7 downgrade)</li><li>6144-MB total system memory (4096 MB + 2048 MB)</li><li>4096-MB total system memory (4096 MB × 1 or 2048 MB × 2)</li><li>2048-MB total system memory (2048 MB × 1)</li></ul>		

# Flash cache

Description	HP EliteBook 725 G2 Notebook PC	HP EliteBook 820 G1 Notebook PC
Support for 32-GB solid-state drive (2242/DS M.2 form factor)		×
Intel SRT (Smart Response Technology)		
Not supported with solid-state drive or self-encrypted drive (SED) hard drive		

# MiniCard solid-state drive

Description	HP EliteBook 725 G2 Notebook PC	HP EliteBook 820 G1 Notebook PC
120-GB solid-state drive (2242/DS M.2 form factor)		×
Not supported if 32-GB flash cache is selected		
Set as primary storage if selected		

# Primary storage

Description	HP EliteBook 725 G2 Notebook PC	HP EliteBook 820 G1 Notebook PC
Support for <b>6.35-cm</b> (2.5-in) hard drives in <b>7.0-mm</b> (.28-in) and <b>9.5-mm</b> (.37-in) thickness	x	x
Support for Serial ATA Support for 3D DriveGuard hard drive protection		
Support toolless removal		
Support for the following hard drive:	x	
<ul style="list-style-type: none"> <li>• 1-TB, 5400-rpm, SATA, 7.0-mm hard drive</li> </ul>		
Support for the following hard drives:		x
<ul style="list-style-type: none"> <li>• 500-GB, 5400-rpm, SATA, 7.0-mm hard drive</li> </ul>		
<ul style="list-style-type: none"> <li>• 500-GB, 5400-rpm, SATA, locked, 7.0-mm hard drive</li> </ul>		
Support for the following hard drives:	x	x
<ul style="list-style-type: none"> <li>• 500-GB, 7200-rpm, SATA, 7.0-mm hard drive</li> </ul>		
<ul style="list-style-type: none"> <li>• 500-GB, 7200-rpm, SED, 7.0-mm hard drive</li> </ul>		
<ul style="list-style-type: none"> <li>• 500-GB, 5400-rpm, SATA, FIPS, 7.0-mm hard drive</li> </ul>		
<ul style="list-style-type: none"> <li>• 320-GB, 7200-rpm, SATA, 7.0-mm hard drive</li> </ul>		

Description	HP EliteBook 725 G2 Notebook PC	HP EliteBook 820 G1 Notebook PC
Support for the following <b>6.35-cm</b> (2.5-in) solid-state drives:	×	
<ul style="list-style-type: none"> <li>• 256-GB, SATA-3, SED, Opal 2, solid-state drive</li> <li>• 256-GB, SATA-3, SED, Opal 1, solid-state drive</li> <li>• 240-GB, SATA-3, solid-state drive</li> <li>• 180-GB, SATA-3, SED, Opal 1, solid-state drive</li> <li>• 180-GB, SATA-3, solid-state drive</li> <li>• 128-GB, SATA-3, solid-state drive</li> </ul>		
Support for the following <b>6.35-cm</b> (2.5-in) solid-state drives:		×
<ul style="list-style-type: none"> <li>• 512-GB, SATA-3, solid-state drive</li> <li>• 256-GB, SATA-3, SED, Opal 2, solid-state drive</li> <li>• 256-GB, SATA-3, Opal 2, locked, solid-state drive</li> <li>• 256-GB, SATA-3, SED solid-state drive</li> <li>• 240-GB, SATA-3, solid-state drive</li> <li>• 180-GB, SATA-3, SED, Opal 1, solid-state drive</li> <li>• 180-GB, SATA-3, solid-state drive</li> <li>• 128-GB, SATA-3, locked, Opal 2, solid-state drive</li> <li>• 128-GB, SATA-3, locked, solid-state drive</li> <li>• 128-GB, SATA-3, solid-state drive</li> <li>• 120-GB, mSATA-3, SED solid-state drive</li> <li>• 32-GB, SATA-3, solid-state drive</li> </ul>		

## Audio and video

Description	HP EliteBook 725 G2 Notebook PC	HP EliteBook 820 G1 Notebook PC
Webcam, 720p	×	×
Dual array microphones		
Stereo speakers		
HD audio with DTS Studio sound		



# Ethernet

Description	HP EliteBook 725 G2 Notebook PC	HP EliteBook 820 G1 Notebook PC
Realtek RTL8111EP 10/100/1000 Ethernet with DASH support	×	
S3/S4/S5 wake on LAN		
Intel I218LM 10/100/1000 Ethernet with iAMT		×
Intel I218LM Gigabit Network Connection		
S3/S4/S5 wake on LAN		

# Wireless networking

Description	HP EliteBook 725 G2 Notebook PC	HP EliteBook 820 G1 Notebook PC
Integrated wireless local area network (WLAN) options by way of wireless module	×	×
Two WLAN antennas built into display assembly		
Support for the following WLAN formats:	×	
<ul style="list-style-type: none"> <li>Atheros AR9485 802.11 b/g/n WiFi Adapter</li> <li>Broadcom BCM943228HMB 802.11 abgn 2x2 Wi-Fi Adapter, Broadcom Bluetooth 4.0 Adapter</li> <li>Broadcom BCM4352 802.11 ac 2x2 Wi-Fi + Bluetooth 4.0 Combo Adapter</li> </ul>		
Support for the following WLAN formats:		×
<ul style="list-style-type: none"> <li>Broadcom BCM943228HMB 802.11 a/b/g/n 2x2 Wi-Fi + Bluetooth 4.0 Combo Adapter</li> <li>Intel Dual Band Wireless-AC 7260 802.11 ac 2x2 Wi-Fi + Bluetooth 4.0 WLAN module</li> <li>Intel Dual Band Wireless-N 7260AN 802.11 a/b/g/n 2x2 Wi-Fi + Bluetooth 4.0 Combo Adapter</li> <li>Intel Dual Band Wireless-N 7260AN 802.11 a/b/g/n 2x2 Wi-Fi + Bluetooth 4.0 Combo Adapter</li> <li>Intel Dual Band Wireless-N 7260NB 802.11 a/b/g/n 2x2 Wi-Fi Adapter</li> </ul>		
Integrated wireless wide area network (WWAN) options by way of wireless module (select models only)	×	×
Two WWAN antennas built into display assembly (select models only)		

Description	HP EliteBook 725 G2 Notebook PC	HP EliteBook 820 G1 Notebook PC
Support for the following WWAN formats:	×	
<ul style="list-style-type: none"> <li>HP hs3110 HSPA+ Mobile Broadband Module</li> <li>HP lt4112 LTE/HSPA+ Mobile Broadband Module</li> <li>HP lt4111 LTE/EV-DO/HSPA+ Mobile Broadband Module</li> </ul>		
Support for the following WWAN formats:		×
<ul style="list-style-type: none"> <li>HP hs3110 HSPA+ Mobile Broadband Module</li> <li>HP lt4226 LTE/HSPA+4G Module</li> <li>HP lt4225 LTE/EV-DO 4G Module</li> <li>HP lt4112 LTE/HSPA+ Mobile Broadband Module</li> <li>HP lt4111 LTE/EV-DO/HSPA+ Mobile Broadband Module</li> </ul>		

## External expansion

Description	HP EliteBook 725 G2 Notebook PC	HP EliteBook 820 G1 Notebook PC
SD media reader slot	×	×
Support for SD, SDHC, SDXC		
Push-push insertion/removal		
SIM slot (populated with WWAN; tool-less user-accessible)		

# Ports

Description	HP EliteBook 725 G2 Notebook PC	HP EliteBook 820 G1 Notebook PC
<ul style="list-style-type: none"><li>• AC adapter, HP Smart (4.5-mm barrel)</li><li>• Audio-in (mono microphone)/audio-out (stereo headphone) combo jack</li><li>• DisplayPort 1.2</li><li>• Docking</li><li>• RJ45 (Ethernet)</li><li>• USB 3.0 charging (1)</li><li>• USB 3.0 (2)</li><li>• VGA (Dsub 15 pin) supporting: 1920x1200 external resolution @ 75 Hz, hot plug and unplug and autodetection for correct output to wide-aspect vs. standard aspect video</li></ul>	×	×

# Docking

Description	HP EliteBook 725 G2 Notebook PC	HP EliteBook 820 G1 Notebook PC
HP 2013 UltraSlim Docking Station	×	×

# Keyboard/pointing devices

Description	HP EliteBook 725 G2 Notebook PC	HP EliteBook 820 G1 Notebook PC
Dual point, spill-resistant (with drain) keyboard with DuraKeys, function keys and optional backlightFunction Keys:	×	×
<b>Touchpad Requirements:</b> Glass with chemical etched surface, on/off button, support for 2-way scroll, Taps enabled as default, Gestures enabled by default (2-finger scrolling, 2-finger zoom (pinch))		

# Power requirements

Description	HP EliteBook 725 G2 Notebook PC	HP EliteBook 820 G1 Notebook PC
Support for removable 3-cell, 46-WHr, 4.15-AHr, Li-ion battery and 3-cell, 26-WHr, 2.50-AHr, Li-ion battery	×	×
Support for the following AC adapters:		
<ul style="list-style-type: none"><li>65-W HP Smart adapter (EM, RC/V, 3-wire, 4.5-mm)</li><li>65-W HP Smart adapter (non-PFC, 3-wire, 4.5-mm)</li><li>45-W HP Smart adapter (non-PFC, RC/V, 3-wire, 4.5-mm)</li></ul>		

# Security

Description	HP EliteBook 725 G2 Notebook PC	HP EliteBook 820 G1 Notebook PC
Support for the following:	×	×
<ul style="list-style-type: none"><li>Fingerprint reader</li><li>Full-volume encryption</li><li>Integrated Smart Card reader (active)</li><li>Preboot authentication (password, Smart Card)</li><li>Support Security Lock</li><li>Trusted Platform Module (TPM) 1.2 (Infineon; soldered down)</li><li>Trusted Platform Module (TPM) 1.2 (Infineon; soldered down)</li></ul>		

# Operating system

Description	HP EliteBook 725 G2 Notebook PC	HP EliteBook 820 G1 Notebook PC
<b>Preinstalled:</b>	x	
<ul style="list-style-type: none"> <li>• Microsoft® Windows® 8.1 Chinese Market 64-bit (available only with People's Republic of China country localization)</li> <li>• Microsoft Windows 8.1 Emerging Market 64-bit</li> <li>• Microsoft Windows 8.1 Multi-language 64-bit</li> <li>• Microsoft Windows 8.1 Professional 64-bit DPK with Windows 7 Professional 64-bit Image</li> <li>• Microsoft Windows 8.1 Professional 64-bit DPK with Windows 7 Professional 64-bit-MSNA</li> <li>• Microsoft Windows 8.1 Professional 64-bit DPK with Windows 7 Professional 32-bit image</li> <li>• Microsoft Windows 8.1 Professional 64-bit DPK with Windows 7 Professional 32-bit-MSNA</li> <li>• Microsoft Windows 7 Home Basic 32-bit, Service Pack 1 (available only if 4096-MB of total system memory [4096-MB × 1] or less is selected)</li> <li>• Microsoft Windows 7 Home Premium 64-bit, Service Pack 1</li> <li>• Microsoft Windows 7 Professional 32-bit, Service Pack 1 (available only if 4096-MB of total system memory [4096-MB × 1] or less is selected)</li> <li>• Microsoft Windows 7 Professional 64-bit, Service Pack 1</li> <li>• Microsoft Windows 7 Professional 32-bit, Service Pack 1 (available only if 4096-MB of total system memory [4096-MB × 1] or less is selected)</li> <li>• Ubuntu Linux</li> <li>• FreeDOS 2.0</li> </ul>		
<b>Restore Media--DRDVD:</b>		
<ul style="list-style-type: none"> <li>• Microsoft Windows 8.1 (available with any Windows 8.1 operating system, required with any Windows 8.1 Professional downgrade operating system)</li> <li>• Microsoft Windows 7 (available with any Windows 7 or Windows 8 Professional downgrade operating system)</li> </ul>		

Description	HP EliteBook 725 G2 Notebook PC	HP EliteBook 820 G1 Notebook PC
<b>Restore Media–SRDVD:</b> Ubuntu Linux	x	
<b>OSDVD:</b>		
<ul style="list-style-type: none"> <li>• Microsoft Windows 8.1 64-bit (for service only)</li> <li>• Microsoft Windows 8.1 CS 64-Bit (for service only)</li> <li>• Microsoft Windows 8.1 Emerging Markets 64-Bit (for service only)</li> <li>• Microsoft Windows 8.1 Professional 64-bit (include in Windows 8.1 downgrade operating system AVs only; do not include for Asia/Pacific countries or regions or the People's Republic of China)</li> <li>• Microsoft Windows 7 Home Basic 32-bit (available with any Windows 7 Home Basic localization except Asia/Pacific countries/regions or the People's Republic of China)</li> <li>• Microsoft Windows 7 Home Premium 64-bit (available with any Windows 7 HP operating system except Asia/Pacific countries/regions or the People's Republic of China)</li> <li>• Microsoft Windows 7 Home Premium 32-bit (available with any Windows 7 HP operating system except Asia/Pacific countries/regions or the People's Republic of China)</li> <li>• Microsoft Windows 7 Professional 64-bit (available with any Windows 7 Professional or Windows 8.1 Professional downgrade localization except Asia/Pacific countries or regions or the People's Republic of China)</li> <li>• Microsoft Windows 7 Professional 32-bit (available with any Windows 7 Professional or Windows 8.1 Professional downgrade localization except Asia/Pacific countries/regions or the People's Republic of China)</li> </ul>		
<b>Certified:</b> Microsoft WHQL		
<b>Web-only Support:</b>		
<ul style="list-style-type: none"> <li>• Microsoft Windows 8.1 Enterprise 64-bit</li> <li>• Microsoft Windows 7 Enterprise 64-bit</li> <li>• Microsoft Windows 7 Enterprise 32-bit</li> </ul>		

Description	HP EliteBook 725 G2 Notebook PC	HP EliteBook 820 G1 Notebook PC
<b>Preinstalled:</b>	x	
<ul style="list-style-type: none"> <li>• Microsoft Windows 8.1 and 8 Chinese Market 64-bit (only available with People's Republic of China country localization)</li> <li>• Microsoft Windows 8.1 and 8 Emerging Market 64-bit</li> <li>• Microsoft Windows 8.1 and 8 Multi-language 64-bit</li> <li>• Microsoft Windows 8.1 and 8 Professional 64-bit</li> <li>• Microsoft Windows 8.1 and 8 Professional 64-bit DPK with Microsoft Windows 7 Professional 64- and 32-bit image</li> <li>• Microsoft Windows 8 Professional 64-bit DPK with Microsoft Windows 7 Professional 64- and 32-bit image–MSNA</li> <li>• Microsoft Windows 8 Professional 64-bit–MSNA</li> <li>• Microsoft Windows 7 Home Basic 32-bit</li> <li>• Microsoft Windows 7 Home Premium 64- and 32-bit</li> <li>• Microsoft Windows 7 Professional 64- and 32-bit</li> <li>• Microsoft Windows 7 Professional 64- and 32-bit–MSNA (only in Asia/Pacific countries and regions and the People's Republic of China)</li> <li>• FreeDOS 2.0</li> <li>• SuSE Linux Enterprise (SLED 11, Service Pack 2, 64-bit; not available on computer models equipped with WWAN capability)</li> </ul>		
<b>Restore Media–DRDVD:</b>		
<ul style="list-style-type: none"> <li>• DRDVD Microsoft Windows 8.1 (available with any Windows 8.1 operating system; required with any Windows 8.1 downgrade operating system)</li> <li>• DRDVD Microsoft Windows 8 (available with any Windows 8 operating system; required with any Windows 8 downgrade operating system)</li> <li>• Microsoft Windows 7 (available with any Windows 7 or Windows 8 downgrade operating system)</li> <li>• SRDVD SuSE Linux Enterprise (SLED, service pack 2, 64-bit; available only with FreeDOS 2.0 and SuSE)</li> </ul>		

Description	HP EliteBook 725 G2 Notebook PC	HP EliteBook 820 G1 Notebook PC
<b>Restore Media–OSDVD:</b>		x
<ul style="list-style-type: none"> <li>• Microsoft Windows 8.1 and 8 Professional 64-bit (include in Windows 8.1 and 8 downgrade operating system AV only; do not include for Asia/Pacific countries or regions or the People's Republic of China)</li> <li>• Microsoft Windows 8 64-bit (for service only)</li> <li>• Microsoft Windows 8 Country Specific 64-bit (for service only)</li> <li>• Microsoft Windows 8 Emerging Market 64-bit (for service only)</li> <li>• Microsoft Windows 7 Home Basic 32-bit (available with any Microsoft Windows 7 Home Basic localization except for Asia/Pacific countries or regions or the People's Republic of China)</li> <li>• Microsoft Windows 7 Home Premium 64- and 32-bit (available with any Microsoft Windows 7 Professional or Microsoft Windows 8 downgrade localization except for Asia/Pacific countries or regions or the People's Republic of China)</li> <li>• Microsoft Windows 7 Professional 64- and 32-bit (available with any Microsoft Windows 7 Professional or Microsoft Windows 8 downgrade localization except for Asia/Pacific countries or regions or the People's Republic of China)</li> </ul>		
<b>Certified:</b>		
<ul style="list-style-type: none"> <li>• Microsoft WHQL</li> <li>• SuSE Linux Enterprise (SLED, service pack 2, 64-bit)</li> </ul>		
<b>Web-only Support:</b>		
<ul style="list-style-type: none"> <li>• Microsoft Windows 8.1 Chinese market 64-bit</li> <li>• Microsoft Windows 8.1 Emerging market 64-bit</li> <li>• Microsoft Windows 8.1 Multi-Language 64-bit</li> <li>• Microsoft Windows 8.1 Enterprise 64-bit</li> <li>• Microsoft Windows 8.1 Pro 64-bit</li> <li>• Microsoft Windows 7 Ultimate 64- and 32-bit</li> <li>• Microsoft Windows 7 Enterprise 64- and 32-bit</li> </ul>		



# Serviceability

Description	HP EliteBook 725 G2 Notebook PC	HP EliteBook 820 G1 Notebook PC
<b>End user replaceable parts:</b>	×	×
<ul style="list-style-type: none"><li>• AC adapter</li><li>• Battery (system)</li><li>• Hard drive</li><li>• Keyboard</li><li>• Memory module</li><li>• Solid-state drive</li><li>• WLAN module</li><li>• WWAN module</li></ul>		



## 2 External component identification

### Display



Item	Component	Description
(1)	WLAN antennas (2)*	Send and receive wireless signals to communicate with wireless local area networks.  <b>NOTE:</b> To set up a WLAN and connect to the Internet, you need a broadband modem (either DSL or cable) (purchased separately), high-speed Internet service, purchased from an Internet service provider, and a wireless router (purchased separately).
(2)	WWAN antennas (2)*	Send and receive wireless signals to communicate with wireless wide area networks.
(3)	Internal microphones	Record sound.
(4)	Webcam light (select models only)	On: The webcam is in use.

Item	Component	Description
(5)	Webcam (select models only)	Records video and captures still photographs.  To use the webcam, select <b>Start &gt; All Programs &gt; Communication and Chat &gt; HP Webcam</b> .
(6)	Internal display switch	Turns off the display and initiates Sleep if the display is closed while the power is on.  <b>NOTE:</b> The internal display switch is not visible from the outside of the computer.

\*The antennas are not visible from the outside of the computer. For optimal transmission, keep the areas immediately around the antennas free from obstructions. To see wireless regulatory notices, see the section of the *Regulatory, Safety, and Environmental Notices* that applies to your country or region. These notices are located in Help and Support.

## Buttons and fingerprint reader (select models only)

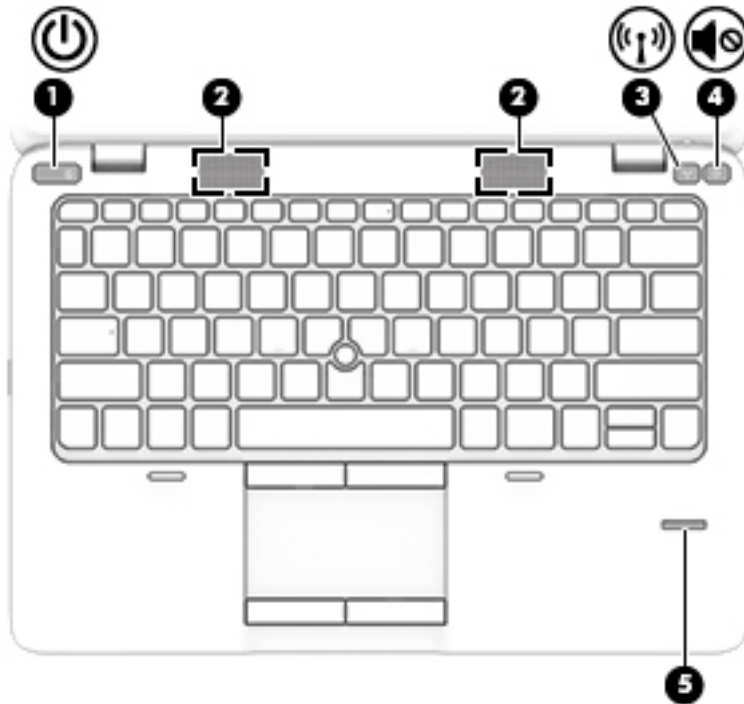

Item	Component	Description
(1)	Power button	<ul style="list-style-type: none"> <li>When the computer is off, press the button to turn on the computer.</li> <li>When the computer is on, press the button briefly to initiate Sleep.</li> <li>When the computer is in the Sleep state, press the button briefly to exit Sleep.</li> <li>When the computer is in Hibernation, press the button briefly to exit Hibernation.</li> </ul> <p>If the computer has stopped responding and Microsoft Windows shutdown procedures are ineffective, press and hold the power button for at least 5 seconds to turn off the computer.</p> <p>To learn more about your power settings:</p> <ul style="list-style-type: none"> <li>Select <b>Start &gt; Control Panel &gt; System and Security &gt; Power Options</b>.</li> <li>For more information, see the <i>HP Notebook Reference Guide</i>.</li> </ul>
(2)	Speakers	Produce sound.
(3)	Wireless button	Turns the wireless feature on or off but does not establish a wireless connection.
(4)	Volume mute button	Mutes and restores speaker sound.
(5)	Fingerprint reader (select models only)	Allows a fingerprint logon to Windows, instead of a password logon.

# Keys

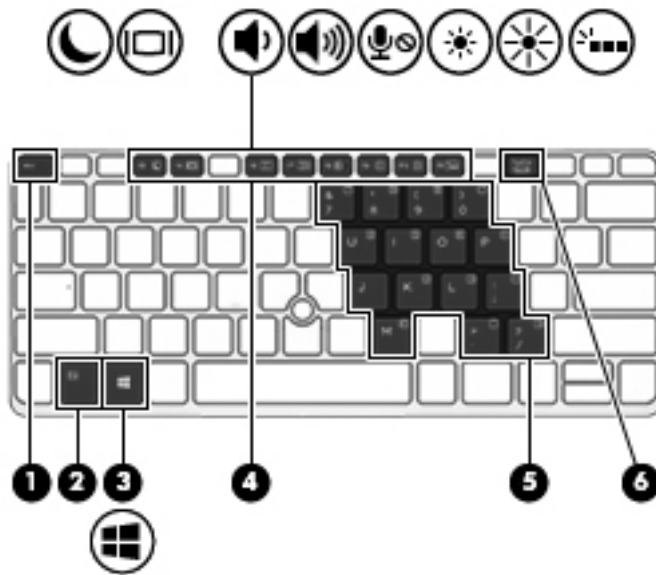

Item	Component	Description
(1)	<b>esc</b> key	Displays system information when pressed in combination with the <b>fn</b> key.
(2)	<b>fn</b> key	Executes frequently used system functions when pressed in combination with a function key, the <b>num lk</b> key, the <b>esc</b> key, or other keys.
(3)	Windows logo key	Displays the Windows Start menu.
(4)	Function keys	Execute frequently used system functions when pressed in combination with the <b>fn</b> key.
(5)	Embedded numeric keypad	When the keypad is turned on, it can be used like an external numeric keypad. Each key on the keypad performs the function indicated by the icon in the upper-right corner of the key.
(6)	<b>num lk</b> key	Turns the embedded numeric keypad on and off when pressed in combination with the <b>fn</b> key. Alternates between the navigational and numeric functions on the integrated numeric keypad.

# Lights

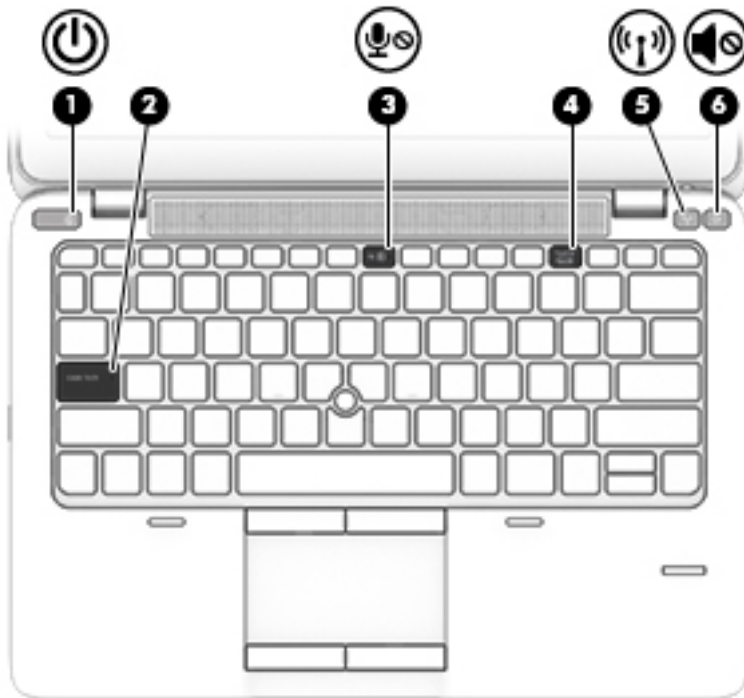

Item	Component	Description
(1)	Power light	<ul style="list-style-type: none"><li>• On: The computer is on.</li><li>• Blinking: The computer is in the Sleep state.</li><li>• Off: The computer is off or in Hibernation.</li></ul>
(2)	Caps lock light	On: Caps lock is on.
(3)	Microphone mute light	On: Microphone is muted.
(4)	Num lock light	On: Num lock is on.
(5)	Wireless light	<ul style="list-style-type: none"><li>• White: An integrated wireless device, such as a wireless local area network (WLAN) device, is on.</li><li>• Amber: All wireless devices are off.</li></ul>
(6)	Mute light	<ul style="list-style-type: none"><li>• Off: Computer sound is on.</li><li>• Amber: Computer sound is off.</li></ul>

# TouchPad

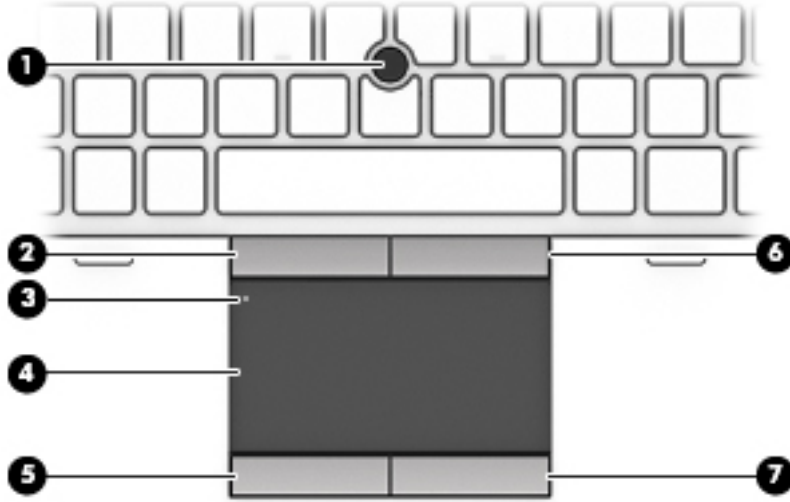

Item	Component	Description
(1)	Pointing stick	Moves the pointer and selects or activates items on the screen.
(2)	Left pointing stick button	Functions like the left button on an external mouse.
(3)	TouchPad on/off button	Turns the TouchPad on and off.
(4)	TouchPad zone	Moves the pointer and selects or activates items on the screen.
(5)	Left TouchPad button	Functions like the left button on an external mouse.
(6)	Right pointing stick button	Functions like the right button on an external mouse.
(7)	Right TouchPad button	Functions like the right button on an external mouse.



# Front



Item	Component	Description
(1)	Wireless light	The wireless connection is on.
(2)	Power light	<ul style="list-style-type: none"><li>• On: The computer is on.</li><li>• Blinking: The computer is in the Sleep state.</li><li>• Off: The computer is off or in Hibernation.</li></ul>
(3)	AC adapter/battery light	<ul style="list-style-type: none"><li>• Amber: The computer is connected to external power and the battery is charged from 0 to 90 percent.</li><li>• White: The computer is connected to external power and the battery is charged from 90 to 99 percent.</li><li>• Blinking amber: A battery that is the only available power source has reached a low battery level. When the battery reaches a critical battery level, the battery light begins blinking rapidly.</li><li>• Off: The battery is fully charged.</li></ul>
(4)	Hard drive light	<ul style="list-style-type: none"><li>• Blinking white: The hard drive is being accessed.</li><li>• Amber: HP 3D DriveGuard has temporarily parked the hard drive.</li></ul> <p><b>NOTE:</b> For information on HP 3D DriveGuard, see the <i>HP Notebook Reference Guide</i>.</p>

## Left side

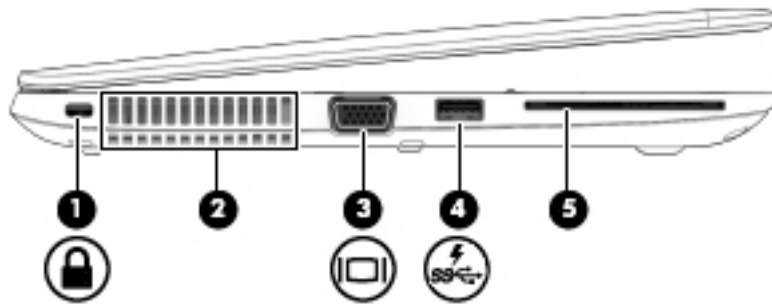

Item	Component	Description
(1)	Security cable slot	Attaches an optional security cable to the computer. <b>NOTE:</b> The security cable is designed to act as a deterrent, but it may not prevent the computer from being mishandled or stolen.
(2)	Vents (2)	Enable airflow to cool internal components. <b>NOTE:</b> The computer fan starts up automatically to cool internal components and prevent overheating. It is normal for the internal fan to cycle on and off during routine operation.
(3)	External VGA monitor port	Connects an external VGA monitor or projector.
(4)	USB 3.0 charging port	Connects an optional USB device. The USB charging port can also charge select models of cell phones and MP3 players, even when the computer is off. <b>NOTE:</b> A USB charging port (also referred to as a powered USB port) allows you to charge connected USB devices. Standard USB ports will not charge all USB devices or will charge using a low current. Some USB devices require power and require you to use a powered port.
(5)	Smart card reader	Supports optional smart cards.

## Right side

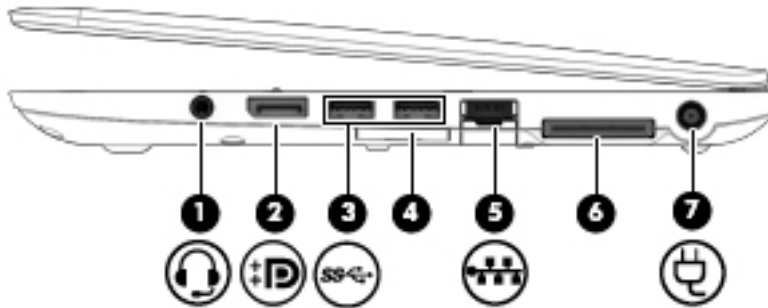

Item	Component	Description
(1)	Audio-out (headphone) jack/Audio-in (microphone) combo jack	<p>Produces sound when connected to optional powered stereo speakers, headphones, earbuds, a headset, or television audio. Also connects an optional headset microphone.</p> <p><b>WARNING!</b> To reduce the risk of personal injury, adjust the volume before putting on headphones, earbuds, or a headset. For additional safety information, see the <i>Regulatory, Safety, and Environmental Notices</i>.</p> <p><b>NOTE:</b> When a device is connected to the jack, the computer speakers are disabled.</p> <p><b>NOTE:</b> Be sure that the device cable has a 4-conductor connector that supports both audio-out (headphone) and audio-in (microphone).</p>
(2)	DisplayPort	Connects an optional digital display device, such as a highperformance monitor or projector.
(3)	USB 3.0 ports (2)	Connect optional USB 3.0 devices and provide enhanced USB power performance.
(4)	Memory card reader	Reads data from and writes data to memory cards such as Secure Digital (SD).
(5)	RJ-45 (network) jack	Connects a network cable.
(6)	Docking port	Connects an optional docking device.
(7)	Power connector	Connects an AC adapter.

# Bottom

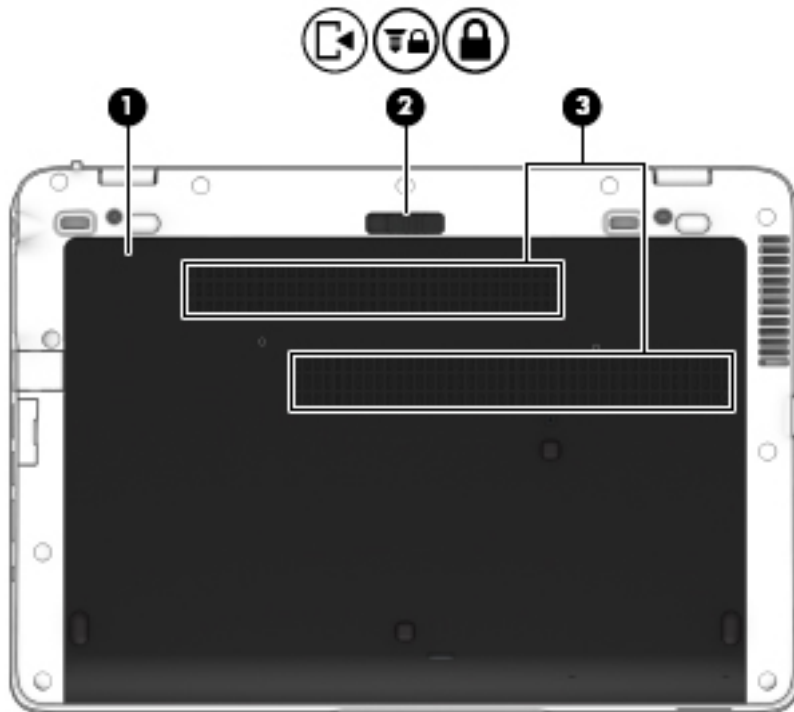

Item	Component	Description
(1)	Service cover	<p>Provides access to the hard drive bay, the WLAN module slot, the WWAN module slot, and the memory module slots.</p> <p><b>CAUTION:</b> To prevent an unresponsive system, replace the wireless module only with a wireless module authorized for use in the computer by the governmental agency that regulates wireless devices in your country or region. If you replace the module and then receive a warning message, remove the module to restore computer functionality, and then contact support through Help and Support.</p>
(2)	Service cover release latch	<p>Releases the service cover from the computer. A security screw is available to prevent the service cover from being accidentally removed.</p>
(3)	Vents (2)	<p>Enable airflow to cool internal components.</p> <p><b>NOTE:</b> The computer fan starts up automatically to cool internal components and prevent overheating. It is normal for the internal fan to cycle on and off during routine operation.</p>

---

## 3 Illustrated parts catalog

 **NOTE:** HP continually improves and changes product parts. For complete and current information on supported parts for your computer, go to <http://partsurfer.hp.com>, select your country or region, and then follow the on-screen instructions.

---

### Locating the serial number, product number, and model number

The serial number and product number of your tablet are located on the left edge of the tablet. The model number of your tablet is located on the back of your tablet. You may need the information when you travel internationally or when you contact support.

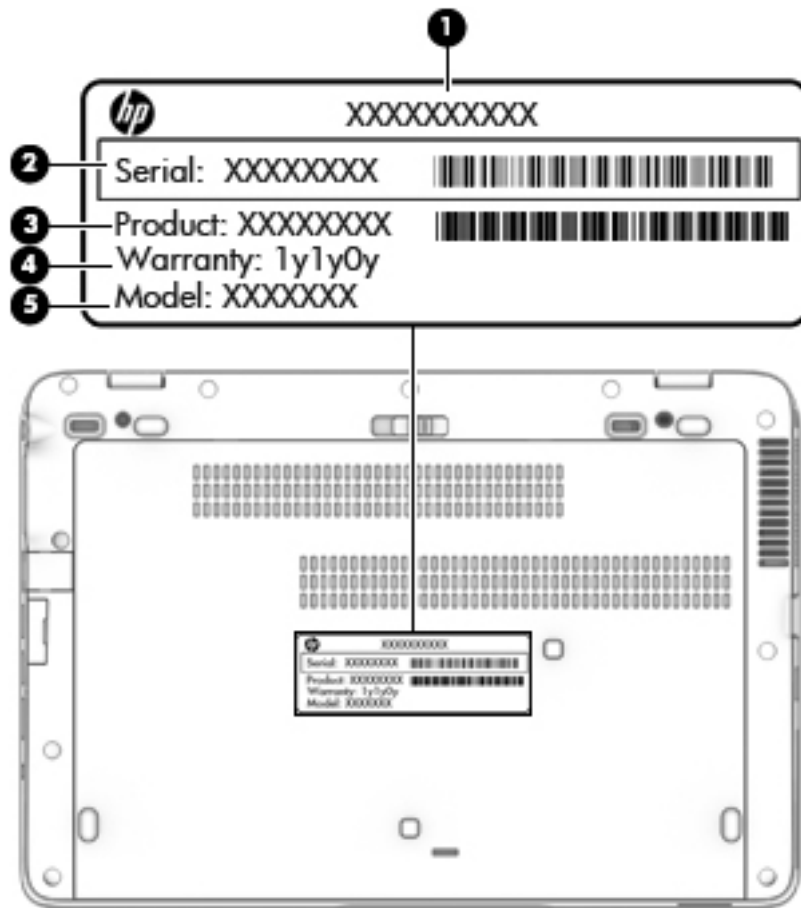

# Computer major components

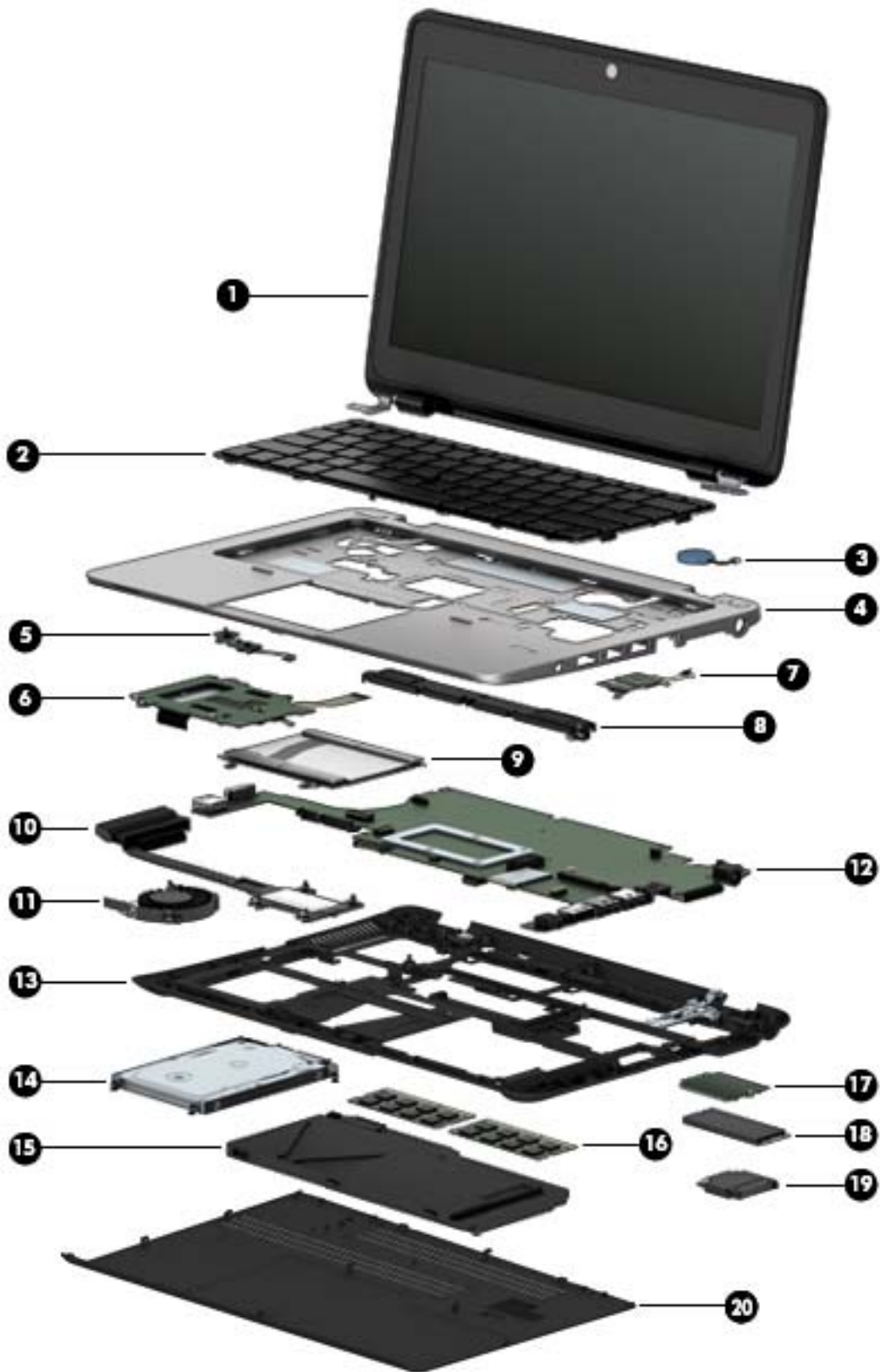

Item	Component	Spare part number
<b>(1)</b>	<b>Display assembly:</b> The TouchScreen display assembly is spared as a whole unit replacement.	
	12.5-in, AntiGlare, FHD, LED, UWVA, TouchScreen display assembly for use only on computer models equipped with an AMD processor	765606-001
	12.5-in, AntiGlare, HD, LED, UWVA, TouchScreen display assembly for use only on computer models equipped with an Intel processor	761781-001
	The non-TouchScreen display assembly is spared at the subcomponent level only. For more display assembly spare part information, see <a href="#">Display assembly components on page 41</a> .	
<b>(2)</b>	<b>Keyboard</b> with backlight (includes backlight cable and keyboard cable):	
	For use only on computer models equipped with an AMD processor:	
	For use in Belgium	776452-A41
	For use in Brazil	776452-201
	For use in Bulgaria	776452-BA1
	For use in Canada	776452-DB1
	For use in the Czech Republic and Slovakia	776452-FL1
	For use in Denmark	776452-081
	For use in France	776452-051
	For use in Germany	776452-041
	For use in Greece	776452-151
	For use in Hungary	776452-211
	For use in Iceland	776452-DD1
	For use in India	776452-D61
	For use in Israel	776452-BB1
	For use in Italy	776452-061
	For use in Japan	776452-291
	For use in Latin America	776452-161
	For use in the Netherlands	776452-B31
	For use in Northwest Africa	776452-FP1
	For use in Norway	776452-091
	For use in Portugal	776452-131
	For use in Romania	776452-271
	For use in Russia	776452-251
	For use in Saudi Arabia	776452-171
	For use in Slovenia	776452-BA1



<b>Item</b>	<b>Component</b>	<b>Spare part number</b>
	For use in South Korea	776452-AD1
	For use in Spain	776452-071
	For use in Sweden and Finland	776452-B71
	For use in Switzerland	776452-BG1
	For use in Taiwan	776452-AB1
	For use in Thailand	776452-281
	For use in Turkey	776452-141
	For use in the United Kingdom	776452-031
	For use in the United States	776452-001
	Keyboard with backlight for use only on computer models equipped with an Intel processor:	
	For use in Belgium	730541-A41
	For use in Brazil	730541-201
	For use in Bulgaria	730541-261
	For use in Canada	730541-DB1
	For use in the Czech Republic and Slovakia	730541-FL1
	For use in Denmark	730541-081
	For use in France	730541-051
	For use in Germany	730541-041
	For use in Greece	730541-151
	For use in Hungary	730541-211
	For use in Iceland	730541-DD1
	For use in India	730541-D61
	For use in Israel	730541-BB1
	For use in Italy	730541-061
	For use in Japan	730541-291
	For use in Latin America	730541-161
	For use in the Netherlands	730541-B31
	For use in Northwest Africa	730541-FP1
	For use in Norway	730541-091
	For use in Portugal	730541-131
	For use in Romania	730541-271
	For use in Russia	730541-251

<b>Item</b>	<b>Component</b>	<b>Spare part number</b>
	For use in Saudi Arabia	730541-171
	For use in Slovenia	730541-BA1
	For use in South Korea	730541-AD1
	For use in Spain	730541-071
	For use in Sweden and Finland	730541-B71
	For use in Switzerland	730541-BG1
	For use in Taiwan	730541-AB1
	For use in Thailand	730541-281
	For use in Turkey	730541-141
	For use in the United Kingdom and Singapore	730541-031
	For use in the United States	730541-001
	<b>Keyboard</b> without backlight (includes keyboard cable):	
	For use only on computer models equipped with an AMD processor:	
	For use in Belgium	776451-A41
	For use in Brazil	776451-201
	For use in Bulgaria	776451-261
	For use in Canada	776451-DB1
	For use in the Czech Republic and Slovakia	776451-FL1
	For use in Denmark	776451-081
	For use in France	776451-051
	For use in Germany	776451-041
	For use in Greece	776451-151
	For use in Hungary	776451-211
	For use in Iceland	776451-DD1
	For use in India	776451-D61
	For use in Israel	776451-BB1
	For use in Italy	776451-061
	For use in Japan	776451-291
	For use in Latin America	776451-161
	For use in the Netherlands	776451-B31
	For use in Northwest Africa	776451-FP1
	For use in Norway	776451-091

<b>Item</b>	<b>Component</b>	<b>Spare part number</b>
	For use in Portugal	776451-131
	For use in Romania	776451-271
	For use in Russia	776451-251
	For use in Saudi Arabia	776451-171
	For use in Slovenia	776451-BA1
	For use in South Korea	776451-AD1
	For use in Spain	776451-071
	For use in Sweden and Finland	776451-B71
	For use in Switzerland	776451-BG1
	For use in Taiwan	776451-AB1
	For use in Thailand	776451-281
	For use in Turkey	776451-141
	For use in the United Kingdom	776451-031
	For use in the United States	776451-001
	Keyboard without backlight for use only on computer models equipped with an Intel processor (includes keyboard cable):	
	For use in Belgium	730540-A41
	For use in Brazil	730540-201
	For use in Bulgaria	730540-261
	For use in Canada	730540-DB1
	For use in the Czech Republic and Slovakia	730540-FL1
	For use in Denmark	730540-081
	For use in France	730540-051
	For use in Germany	730540-041
	For use in Greece	730540-151
	For use in Hungary	730540-211
	For use in Iceland	730540-DD1
	For use in India	730540-D61
	For use in Israel	730540-BB1
	For use in Italy	730540-061
	For use in Japan	730540-291
	For use in Latin America	730540-161
	For use in the Netherlands	730540-B31

<b>Item</b>	<b>Component</b>	<b>Spare part number</b>
	For use in Northwest Africa	730540-FP1
	For use in Norway	730540-091
	For use in Portugal	730540-131
	For use in Romania	730540-271
	For use in Russia	730540-251
	For use in Saudi Arabia	730540-171
	For use in Slovenia	730540-BA1
	For use in South Korea	730540-AD1
	For use in Spain	730540-071
	For use in Sweden and Finland	730540-B71
	For use in Switzerland	730540-BG1
	For use in Taiwan	730540-AB1
	For use in Thailand	730540-281
	For use in Turkey	730540-141
	For use in the United Kingdom and Singapore	730540-031
	For use in the United States	730540-001
<b>(3)</b>	<b>RTC battery</b> (includes cable and double-sided adhesive)	702853-001
<b>(4)</b>	<b>Top cover:</b>	
	For use only on computer models equipped with an AMD processor	783215-001
	For use only on computer models equipped with an Intel processor	730548-001
<b>(5)</b>	<b>Power button board</b> (includes cable)	730552-001
<b>(6)</b>	<b>Speaker assembly</b> (includes left and right speakers and cables)	730555-001
<b>(7)</b>	<b>Fingerprint reader board</b> (includes bracket and cable)	730554-001
<b>(8)</b>	<b>Card reader board</b> (includes cable)	730563-001
<b>(9)</b>	<b>System board</b> (includes a graphics subsystem with UMA memory and replacement thermal material):	
	For use only on computer models equipped with an AMD processor:	
	Equipped with an AMD A10 Pro-7350B 2.10-GHz (SC turbo up to 3.30-GHz) quad core processor (4.00-MB L2 cache, 19 W), a graphics subsystem with UMA memory, and the Windows 8 Professional operating system	765617-601
	Equipped with an AMD A10 Pro-7350B 2.10-GHz (SC turbo up to 3.30-GHz) quad core processor (4.00-MB L2 cache, 19 W), a graphics subsystem with UMA memory, and the Windows 8 Standard operating system	765617-501
	Equipped with an AMD A10 Pro-7350B 2.10-GHz (SC turbo up to 3.30-GHz) quad core processor (4.00-MB L2 cache, 19 W), a graphics subsystem with UMA memory, and a non-Windows 8 operating system	765617-001

<b>Item</b>	<b>Component</b>	<b>Spare part number</b>
	Equipped with an AMD A8 Pro-7150B 2.00-GHz (SC turbo up to 3.20-GHz) quad core processor (4.00-MB L2 cache, 19 W), a graphics subsystem with UMA memory, and the Windows 8 Professional operating system	765616-601
	Equipped with an AMD A8 Pro-7150B 2.00-GHz (SC turbo up to 3.20-GHz) quad core processor (4.00-MB L2 cache, 19 W), a graphics subsystem with UMA memory, and the Windows 8 Standard operating system	765616-501
	Equipped with an AMD A8 Pro-7150B 2.00-GHz (SC turbo up to 3.20-GHz) quad core processor (4.00-MB L2 cache, 19 W), a graphics subsystem with UMA memory, and a non-Windows 8 operating system	765616-001
	Equipped with an AMD A6 Pro-7050B 2.20-GHz (SC turbo up to 3.00-GHz) dual core processor (1.00-MB L2 cache, 17 W), a graphics subsystem with UMA memory, and the Windows 8 Professional operating system	765615-601
	Equipped with an AMD A6 Pro-7050B 2.20-GHz (SC turbo up to 3.00-GHz) dual core processor (1.00-MB L2 cache, 17 W), a graphics subsystem with UMA memory, and the Windows 8 Standard operating system	765615-501
	Equipped with an AMD A6 Pro-7050B 2.20-GHz (SC turbo up to 3.00-GHz) dual core processor (1.00-MB L2 cache, 17 W), a graphics subsystem with UMA memory, and a non-Windows 8 operating system	765615-001
	For use only on computer models equipped with an Intel processor and a TouchScreen display assembly:	
	Equipped with an Intel Core i7-4600U 2.10-GHz (SC turbo up to 3.10-GHz) processor (4.00-MB L3 cache, 15 W) and the Windows 8 Professional operating system	761778-601
	Equipped with an Intel Core i7-4600U 2.10-GHz (SC turbo up to 3.10-GHz) processor (4.00-MB L3 cache, 15 W) and the Windows 8 Standard operating system	761778-501
	Equipped with an Intel Core i7-4600U 2.10-GHz (SC turbo up to 3.10-GHz) processor (4.00-MB L3 cache, 15 W) and a non-Windows 8 operating system	761778-001
	Equipped with an Intel Core i7-4510U 2.00-GHz (SC turbo up to 3.10-GHz) processor (4.00-MB L3 cache, 15 W), a graphics subsystem with UMA memory, and the Windows 8 Professional operating system	778831-601
	Equipped with an Intel Core i7-4510U 2.00-GHz (SC turbo up to 3.10-GHz) processor (4.00-MB L3 cache, 15 W), a graphics subsystem with UMA memory, and the Windows 8 Professional operating system	778831-501
	Equipped with an Intel Core i7-4510U 2.00-GHz (SC turbo up to 3.10-GHz) processor (4.00-MB L3 cache, 15 W), a graphics subsystem with UMA memory, and a non-Windows 8 operating system	778831-001
	Equipped with an Intel Core i7-4500U 1.80-GHz (SC turbo up to 3.00-GHz) processor (4.00-MB L3 cache, 15 W) and the Windows 8 Professional operating system	761777-601
	Equipped with an Intel Core i7-4500U 1.80-GHz (SC turbo up to 3.00-GHz) processor (4.00-MB L3 cache, 15 W) and the Windows 8 Standard operating system	761777-501
	Equipped with an Intel Core i7-4500U 1.80-GHz (SC turbo up to 3.00-GHz) processor (4.00-MB L3 cache, 15 W) and a non-Windows 8 operating system	761777-001

<b>Item</b>	<b>Component</b>	<b>Spare part number</b>
	Equipped with an Intel Core i5-4310U 2.00-GHz (SC turbo up to 3.00-GHz) processor (3.00-MB L3 cache, 15 W), a graphics subsystem with UMA memory, and the Windows 8 Professional operating system	778830-601
	Equipped with an Intel Core i5-4310U 2.00-GHz (SC turbo up to 3.00-GHz) processor (3.00-MB L3 cache, 15 W), a graphics subsystem with UMA memory, and the Windows 8 Standard operating system	778830-501
	Equipped with an Intel Core i5-4310U 2.00-GHz (SC turbo up to 3.00-GHz) processor (3.00-MB L3 cache, 15 W), a graphics subsystem with UMA memory, and a non-Windows 8 operating system	778830-001
	Equipped with an Intel Core i5-4300U 1.90-GHz (SC turbo up to 2.90-GHz) processor (3.00-MB L3 cache, 15 W) and the Windows 8 Professional operating system	761776-601
	Equipped with an Intel Core i5-4300U 1.90-GHz (SC turbo up to 2.90-GHz) processor (3.00-MB L3 cache, 15 W) and the Windows 8 Standard operating system	761776-501
	Equipped with an Intel Core i5-4300U 1.90-GHz (SC turbo up to 2.90-GHz) processor (3.00-MB L3 cache, 15 W) and a non-Windows 8 operating system	761776-001
	Equipped with an Intel Core i5-4210U 1.70-GHz (SC turbo up to 2.70-GHz) processor (3.00-MB L3 cache, 15 W), a graphics subsystem with UMA memory, and the Windows 8 Professional operating system	778829-601
	Equipped with an Intel Core i5-4210U 1.70-GHz (SC turbo up to 2.70-GHz) processor (3.00-MB L3 cache, 15 W), a graphics subsystem with UMA memory, and the Windows 8 Standard operating system	778829-501
	Equipped with an Intel Core i5-4210U 1.70-GHz (SC turbo up to 2.70-GHz) processor (3.00-MB L3 cache, 15 W), a graphics subsystem with UMA memory, and a non-Windows 8 operating system	778829-001
	Equipped with an Intel Core i5-4200U 1.60-GHz (SC turbo up to 2.60-GHz) processor (3.00-MB L3 cache, 15 W) and the Windows 8 Professional operating system	761775-601
	Equipped with an Intel Core i5-4200U 1.60-GHz (SC turbo up to 2.60-GHz) processor (3.00-MB L3 cache, 15 W) and the Windows 8 Standard operating system	761775-501
	Equipped with an Intel Core i5-4200U 1.60-GHz (SC turbo up to 2.60-GHz) processor (3.00-MB L3 cache, 15 W) and a non-Windows 8 operating system	761775-001
	Equipped with an Intel Core i3-4030U 1.90-GHz processor (3.00-MB L3 cache, 15 W), a graphics subsystem with UMA memory, and the Windows 8 Professional operating system	778828-601
	Equipped with an Intel Core i3-4030U 1.90-GHz processor (3.00-MB L3 cache, 15 W), a graphics subsystem with UMA memory, and the Windows 8 Standard operating system	778828-501
	Equipped with an Intel Core i3-4030U 1.90-GHz processor (3.00-MB L3 cache, 15 W), a graphics subsystem with UMA memory, and a non-Windows 8 operating system	778828-001
	Equipped with an Intel Core i3-4010U 1.70-GHz processor (3.00-MB L3 cache, 15 W), a graphics subsystem with UMA memory, and the Windows 8 Professional operating system	761774-601

Item	Component	Spare part number
	Equipped with an Intel Core i3-4010U 1.70-GHz processor (3.00-MB L3 cache, 15 W), a graphics subsystem with UMA memory, and the Windows 8 Standard operating system	761774-501
	Equipped with an Intel Core i3-4010U 1.70-GHz processor (3.00-MB L3 cache, 15 W), a graphics subsystem with UMA memory, and a non-Windows 8 operating system	761774-001
	For use only on computer models equipped with an Intel processor and a non-TouchScreen display assembly:	
	Equipped with an Intel Core i7-4600U 2.10-GHz (SC turbo up to 3.30-GHz) processor (4.00-MB L3 cache, 15 W) and the Windows 8 Professional operating system	730559-601
	Equipped with an Intel Core i7-4600U 2.10-GHz (SC turbo up to 3.30-GHz) processor (4.00-MB L3 cache, 15 W) and the Windows 8 Standard operating system	730559-501
	Equipped with an Intel Core i7-4600U 2.10-GHz (SC turbo up to 3.30-GHz) processor (4.00-MB L3 cache, 15 W) and a non-Windows 8 operating system	730559-001
	Equipped with an Intel Core i7-4500U 1.80-GHz (SC turbo up to 3.00-GHz) processor (4.00-MB L3 cache, 15 W) and the Windows 8 Professional operating system	753071-601
	Equipped with an Intel Core i7-4500U 1.80-GHz (SC turbo up to 3.00-GHz) processor (4.00-MB L3 cache, 15 W) and the Windows 8 Standard operating system	753071-501
	Equipped with an Intel Core i7-4500U 1.80-GHz (SC turbo up to 3.00-GHz) processor (4.00-MB L3 cache, 15 W) and a non-Windows 8 operating system	753071-001
	Equipped with an Intel Core i5-4300U 1.90-GHz (SC turbo up to 2.90-GHz) processor (3.00-MB L3 cache, 15 W) and the Windows 8 Professional operating system	731066-601
	Equipped with an Intel Core i5-4300U 1.90-GHz (SC turbo up to 2.90-GHz) processor (3.00-MB L3 cache, 15 W) and the Windows 8 Standard operating system	731066-501
	Equipped with an Intel Core i5-4300U 1.90-GHz (SC turbo up to 2.90-GHz) processor (3.00-MB L3 cache, 15 W) and a non-Windows 8 operating system	731066-001
	Equipped with an Intel Core i5-4200U 1.60-GHz (SC turbo up to 2.60-GHz) processor (3.00-MB L3 cache, 15 W) and the Windows 8 Professional operating system	730558-601
	Equipped with an Intel Core i5-4200U 1.60-GHz (SC turbo up to 2.60-GHz) processor (3.00-MB L3 cache, 15 W) and the Windows 8 Standard operating system	730558-501
	Equipped with an Intel Core i5-4200U 1.60-GHz (SC turbo up to 2.60-GHz) processor (3.00-MB L3 cache, 15 W) and a non-Windows 8 operating system	730558-001
	Equipped with an Intel Core i3-4010U 1.70-GHz processor (3.00-MB L3 cache, 15 W) and the Windows 8 Professional operating system	730557-601
	Equipped with an Intel Core i3-4010U 1.70-GHz processor (3.00-MB L3 cache, 15 W) and the Windows 8 Standard operating system	730557-501
	Equipped with an Intel Core i3-4010U 1.70-GHz processor (3.00-MB L3 cache, 15 W) and a non-Windows 8 operating system	730557-001
<b>(10)</b>	<b>TouchPad</b> (includes cable)	730549-001

Item	Component	Spare part number	
<b>(11)</b>	<b>Heat sink</b> (includes replacement thermal material):		
	For use only on computer models equipped with an AMD processor	765605-001	
	For use only on computer models equipped with an Intel processor	730556-001	
<b>(12)</b>	<b>Fan</b> (includes cable):		
	For use only on computer models equipped with an AMD processor	780895-001	
	For use only on computer models equipped with an Intel processor	730547-001	
<b>(13)</b>	<b>Base enclosure</b> (includes RJ-45 cover, rubber feet, and service cover eject latch assembly):		
	For use only on computer models equipped with an AMD processor	765603-001	
	For use only on computer models equipped with an Intel processor	730551-001	
	<b>Rubber Kit</b> (not illustrated, includes base enclosure rubber screw covers)	730550-001	
<b>(14)</b>	<b>Hard drive</b> (does not include hard drive bracket, hard drive connector adapter, or screws):		
	<b>NOTE:</b> The hard drive bracket, hard drive connector adapter, and screws are included in the Hard Drive Hardware Kit, spare part number 730539-001. See for more information on the Hard Drive Hardware Kit.		
	For use on all computer models:		
	500-GB, 7200-rpm, SATA, 7.0-mm hard drive	703267-001	
	500-GB, 7200-rpm, SED, 7.0-mm hard drive	703268-001	
	500-GB, 5400-rpm, SATA, FIPS, 7.0-mm hard drive	730946-001	
	320-GB, 7200-rpm, SATA, 7.0-mm hard drive	634862-001	
	For use only on computer models equipped with an AMD processor:		
	1-TB, 5400-rpm, SATA, 7.0-mm hard drive	762990-001	
	For use only on computer models equipped with an Intel processor:		
	500-GB, 5400-rpm, SATA, 7.0-mm hard drive	683802-001	
	500-GB, 5400-rpm, SATA, locked, 7.0-mm hard drive	763522-001	
	500-GB, 5400-rpm, SATA, locked, 7.0-mm hard drive	776626-001	
	<b>(15)</b>	<b>Battery:</b>	
		3-cell, 46-WHr, 4.15-AHr, Li-ion battery	717378-001
3-cell, 26-WHr, 2.50-AHr, Li-ion battery		717377-001	
<b>(16)</b>	<b>WWAN module:</b>		
	For use only on computer models equipped with an AMD processor:		
	HP hs3110 HSPA+ Mobile Broadband Module	748599-001	
	HP lt4112 LTE/HSPA+ Mobile Broadband Module	740011-001	
	HP lt4111 LTE/EV-DO/HSPA+ Mobile Broadband Module	748021-001	
	For use only on computer models equipped with an Intel processor:		



<b>Item</b>	<b>Component</b>	<b>Spare part number</b>
	HP hs3110 HSPA+ Mobile Broadband Module	723895-001
	HP lt4226 LTE/HSPA+4G Module	736675-001
	HP lt4225 LTE/EV-DO 4G Module	736676-001
	HP lt4112 LTE/HSPA+ Mobile Broadband Module	704031-001
	HP lt4111 LTE/EV-DO/HSPA+ Mobile Broadband Module	704030-001
<b>(17)</b>	<b>Solid-state drive:</b>	
	For use only on computer models equipped with an AMD processor:	
	256-GB, SATA-3, SED, Opal 2, solid-state drive	765614-001
	256-GB, SATA-3, SED, Opal 1, solid-state drive	765613-001
	240-GB, SATA-3, solid-state drive	765612-001
	180-GB, SATA-3, SED, Opal 1, solid-state drive	765611-001
	180-GB, SATA-3, solid-state drive	765610-001
	128-GB, SATA-3, solid-state drive	765609-001
	For use only on computer models equipped with an Intel processor:	
	512-GB, SATA-3, solid-state drive	752103-001
	256-GB, SATA-3, SED, Opal 2, solid-state drive	761906-001
	256-GB, SATA-3, SATA-3, Opal 2, locked, solid-state drive	777832-001
	256-GB, SATA-3, SED solid-state drive	730567-001
	240-GB, SATA-3, solid-state drive	730566-001
	180-GB, SATA-3, SED, Opal 1, solid-state drive	775247-001
	180-GB, SATA-3, solid-state drive	730565-001
	128-GB, SATA-3, locked, Opal 2, solid-state drive	764507-001
	128-GB, SATA-3, locked, solid-state drive	766679-001
	128-GB, SATA-3, solid-state drive	744716-001
	120-GB, mSATA-3, SED solid-state drive	730568-001
	32-GB, SATA-3, solid-state drive	743008-001
<b>(18)</b>	<b>Memory module (PCL3, 12800, 1600-MHz):</b>	
	8 GB	693374-001
	4 GB	691740-001
<b>(19)</b>	<b>WLAN module:</b>	
	For use only on computer models equipped with an AMD processor:	
	Atheros AR9485 802.11 b/g/n WiFi Adapter	675794-001

<b>Item</b>	<b>Component</b>	<b>Spare part number</b>
	Broadcom BCM943228HMB 802.11 abgn 2x2 Wi-Fi Adapter, Broadcom Bluetooth 4.0 Adapter	730668-001
	Broadcom BCM4352 802.11 ac 2x2 Wi-Fi + Bluetooth 4.0 Combo Adapter	724935-001
	For use only on computer models equipped with an Intel processor:	
	Broadcom BCM943228HMB 802.11 a/b/g/n 2x2 Wi-Fi + Bluetooth 4.0 Combo Adapter	697316-001
	Intel Dual Band Wireless-AC 7260 802.11 ac 2x2 WiFi + Bluetooth 4.0 WLAN module	710661-001
	Intel Dual Band Wireless-N 7260AN 802.11 a/b/g/n 2x2 WiFi + Bluetooth 4.0 Combo Adapter	717381-001
	Intel Dual Band Wireless-N 7260AN 802.11 a/b/g/n 2x2 WiFi + Bluetooth 4.0 Combo Adapter	747832-001
	Intel Dual Band Wireless-N 7260NB 802.11 a/b/g/n 2x2 WiFi Adapter	717382-001
<b>(20)</b>	<b>Service cover</b> (includes rubber feet):	
	For use only on computer models equipped with an AMD processor	766018-001
	For use only on computer models equipped with an Intel processor:	
	For use only on computer models equipped with a TouchScreen display assembly	761780-001
	For use only on computer models equipped with a non-TouchScreen display assembly with a CCCO mark	730564-001
	For use only on computer models equipped with a non-TouchScreen display assembly and with RCTO	745308-001

# Display assembly components

 **NOTE:** The display assembly components listed in this section are for use only on computer models equipped with a non-TouchScreen display assembly.

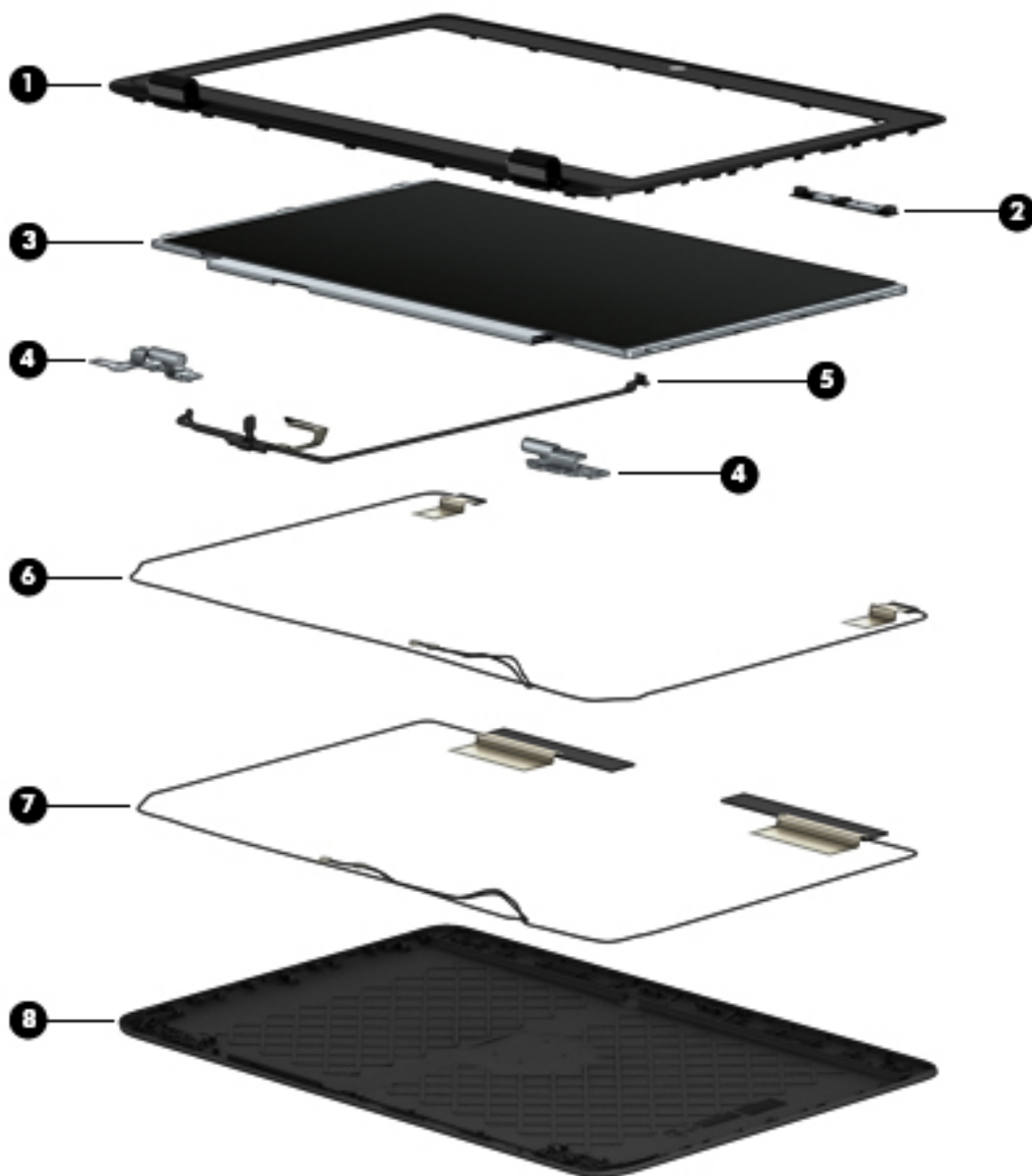

Item	Component	Spare part number
(1)	<b>Display bezel:</b>	
	For use only on computer models equipped with an AMD processor and an AntiGlare, FHD, LED, UWVA display panel	775896-001
	For use only on computer models equipped with an AMD processor and an AntiGlare, HD, LED, SVA display panel	766012-001

<b>Item</b>	<b>Component</b>	<b>Spare part number</b>
	For use only on computer models equipped with an Intel processor and an AntiGlare, HD, LED, SVA display panel	730544-001
<b>(2)</b>	<b>Webcam/microphone module</b> (includes double-sided adhesive):	
	For use only on computer models equipped with an AMD processor	780112-001
	For use only on computer models equipped with an Intel processor	730542-001
	<b>Microphone module</b> (includes double-sided adhesive)	730795-001
<b>(3)</b>	<b>Display panel:</b>	
	For use only on computer models equipped with an AMD processor:	
	12.5-in, AG, FHD, LED, UWVA display panel	776930-001
	12.5-in, AG, HD, LED, SVA display panel	765607-001
	For use only on computer models equipped with an Intel processor:	
	12.5-in, AG, HD, LED, UWVA display panel	730536-001
	12.5-in, AG, HD, LED, SVA display panel	730535-001
<b>(4)</b>	<b>Display Hinge Kit</b> (includes left and right display hinges):	
	For use only on computer models equipped with an AMD processor	775895-001
	For use only on computer models equipped with an Intel processor	730543-001
<b>(5)</b>	<b>Display Cable Kit</b> (includes display panel cable and webcam/microphone module cable)	730537-001
	<b>Antenna Kit</b> , includes:	
<b>(6)</b>	WLAN antenna cables and transceivers	
<b>(7)</b>	WWAN antenna cables and transceivers	
	For use only on computer models equipped with an AMD processor	775894-001
	For use only on computer models equipped with an Intel processor	730560-001
<b>(8)</b>	<b>Display enclosure:</b>	
	For use only on computer models equipped with an AMD processor	775893-001
	For use only on computer models equipped with an Intel processor	730561-001
	<b>Display Panel Support Kit</b> (not illustrated, includes display enclosure, WLAN antenna cables and transceivers, and WWAN antenna cables and transceivers):	
	For use only on computer models equipped with an AMD processor	775897-001
	For use only on computer models equipped with an Intel processor	730538-001

# Plastics Kit



Item	Component	Spare part number
	<b>Plastics Kit</b> , includes:	730562-001
(1)	Card reader bezel	
(2)	Display cable connector bracket	
(3)	Fingerprint reader cover	
(4)	RJ-45 cover	
(5a)	Service cover release latch actuator	
(5b)	Service cover release latch arm	
	Service cover release latch spring (not illustrated)	

# Mass storage devices



Item	Component	Spare part number
(1)	<b>Hard drive</b> (does not include hard drive bracket, hard drive connector adapter, or screws):  <b>NOTE:</b> The hard drive bracket, hard drive connector adapter, and screws are included in the Hard Drive Hardware Kit.	
	For use on all computer models:	
	500-GB, 7200-rpm, SATA, 7.0-mm hard drive	703267-001
	500-GB, 7200-rpm, SED, 7.0-mm hard drive	703268-001
	500-GB, 5400-rpm, SATA, FIPS, 7.0-mm hard drive	730946-001
	320-GB, 7200-rpm, SATA, 7.0-mm hard drive	634862-001
	For use only on computer models equipped with an AMD processor:	
	1-TB, 5400-rpm, SATA, 7.0-mm hard drive	762990-001
	For use only on computer models equipped with an Intel processor:	
	500-GB, 5400-rpm, SATA, 7.0-mm hard drive	683802-001
	500-GB, 5400-rpm, SATA, locked, 7.0-mm hard drive	763522-001

Item	Component	Spare part number
	500-GB, 5400-rpm, SATA, locked, 7.0-mm hard drive	776626-001
	<b>Hard Drive Hardware Kit</b> , includes:	734280-001
<b>(2a)</b>	Hard drive bracket	
<b>(2b)</b>	Hard drive connector adapter	
	Screws (not illustrated)	
<b>(3)</b>	<b>Solid-state drive:</b>	
	For use only on computer models equipped with an AMD processor:	
	256-GB, SATA-3, SED, Opal 2, solid-state drive	765614-001
	256-GB, SATA-3, SED, Opal 1, solid-state drive	765613-001
	240-GB, SATA-3, solid-state drive	765612-001
	180-GB, SATA-3, SED, Opal 1, solid-state drive	765611-001
	180-GB, SATA-3, solid-state drive	765610-001
	128-GB, SATA-3, solid-state drive	765609-001
	For use only on computer models equipped with an Intel processor:	
	512-GB, SATA-3, solid-state drive	752103-001
	256-GB, SATA-3, SED, Opal 2, solid-state drive	761906-001
	256-GB, SATA-3, SATA-3, Opal 2, locked, solid-state drive	777832-001
	256-GB, SATA-3, SED solid-state drive	730567-001
	240-GB, SATA-3, solid-state drive	730566-001
	180-GB, SATA-3, SED, Opal 1, solid-state drive	775247-001
	180-GB, SATA-3, solid-state drive	730565-001
	128-GB, SATA-3, locked, Opal 2, solid-state drive	764507-001
	128-GB, SATA-3, locked, solid-state drive	766679-001
	128-GB, SATA-3, solid-state drive	744716-001
	120-GB, mSATA-3, SED solid-state drive	730568-001
	32-GB, SATA-3, solid-state drive	743008-001

## Miscellaneous parts

Component	Spare part number
<b>AC adapter:</b>	
65-W HP Smart adapter (EM, RC/V, 3-wire, 4.5-mm)	693710-001

<b>Component</b>	<b>Spare part number</b>
65-W HP Smart adapter (non-PFC, 3-wire, 4.5-mm)	693711-001
65-W HP Smart travel adapter (non-PFC)	693716-001
45-W HP Smart adapter (non-PFC, RC, 7.4-mm)	744893-001
45-W HP Smart adapter (non-PFC, RC, 3-wire, 4.5-mm)	721092-001
45-W HP Smart adapter (non-PFC, RC, 2-wire, 4.5-mm)	742437-001
<b>Carrying case:</b>	
HP Essential backpack carrying case	679923-001
HP Essential messenger bag style carrying case	679922-001
HP Essential top-load carrying case	679921-001
HP professional top-load carrying case	705621-001
HP business slim top-load carrying case	718549-001
HP business top-load carrying case	718550-001
<b>HP Travel Smart 3-W DC Cable</b>	630380-001
<b>HP DisplayPort-to-HDMI 1.4 adapter</b>	749288-001
<b>HP 2013 UltraSlim Docking Station</b>	732252-001
<b>HP DisplayPort-to-HDMI cable</b>	617450-001
<b>HP Mobile Connect SIM module</b>	714749-001
<b>Lock:</b>	
HP docking station cable lock	575921-001
HP notebook combination lock	591699-001
HP ultraslim keyed cable lock	703372-001
<b>Mouse:</b>	
HP comfort-grip wireless mouse	691922-001
HP USB laser mouse	674318-001
HP USB optical travel mouse	434594-001
<b>Power cord (3-pin, black, 1.83-m):</b>	
For use in Argentina	490371-D01
For use in Australia	490371-011
For use in Brazil	490371-202
For use in Denmark	490371-081
For use in Europe	490371-021
For use in India	490371-D61



<b>Component</b>	<b>Spare part number</b>
For use in Israel	490371-BB1
For use in Italy	490371-061
For use in Japan	490371-291
For use in North America	490371-001
For use in the People's Republic of China	490371-AA1
For use in South Africa	490371-AR1
For use in South Korea	490371-AD1
For use in Switzerland	490371-111
For use in Taiwan	490371-AB1
For use in Thailand	490371-201
For use in the United Kingdom and Singapore	490371-031
<b>Power cord</b> (3-pin, black, 1.00-m):	
For use in Argentina	755530-D01
For use in Australia	755530-011
For use in Brazil	755530-202
For use in Denmark	755530-081
For use in Europe	755530-021
For use in India	755530-D61
For use in Israel	755530-BB1
For use in Italy	755530-061
For use in Japan	762689-291 and 755530-291
For use in North America	755530-001
For use in the People's Republic of China	755530-AA1
For use in South Africa	755530-AR1
For use in South Korea	755530-AD1
For use in Switzerland	755530-111
For use in Taiwan	755530-AB1
For use in Thailand	755530-201
For use in the United Kingdom and Singapore	755530-031
<b>Screw Kit</b>	730553-001
<b>HP USB 3.0 port replicator</b>	690650-001

# Sequential part number listing

Spare part number	Description
434594-001	HP USB optical travel mouse
490371-001	Power cord for use in North America (3-pin, black, 1.83-m)
490371-011	Power cord for use in Australia (3-pin, black, 1.83-m)
490371-021	Power cord for use in Europe (3-pin, black, 1.83-m)
490371-031	Power cord for use in the United Kingdom and Singapore (3-pin, black, 1.83-m)
490371-061	Power cord for use in Italy (3-pin, black, 1.83-m)
490371-081	Power cord for use in Denmark (3-pin, black, 1.83-m)
490371-111	Power cord for use in Australia (3-pin, black, 1.83-m)
490371-201	Power cord for use in Thailand (3-pin, black, 1.83-m)
490371-202	Power cord for use in Brazil (3-pin, black, 1.83-m)
490371-291	Power cord for use in Japan (3-pin, black, 1.83-m)
490371-AA1	Power cord for use in the People's Republic of China (3-pin, black, 1.83-m)
490371-AB1	Power cord for use in Taiwan (3-pin, black, 1.83-m)
490371-AD1	Power cord for use in South Korea (3-pin, black, 1.83-m)
490371-AR1	Power cord for use in South Africa (3-pin, black, 1.83-m)
490371-BB1	Power cord for use in Israel (3-pin, black, 1.83-m)
490371-D01	Power cord for use in Argentina (3-pin, black, 1.83-m)
490371-D61	Power cord for use in India (3-pin, black, 1.83-m)
575921-001	HP docking station cable lock
591699-001	HP notebook combination lock
617450-001	HP DisplayPort-to-HDMI cable
630380-001	HP Travel Smart 3-W DC Cable
634862-001	320-GB, 7200-rpm, SATA, 7.0-mm hard drive for use on all computer models (does not include hard drive bracket, hard drive connector adapter, or screws)
	<b>NOTE:</b> The hard drive bracket, hard drive connector adapter, and screws are included in the Hard Drive Hardware Kit, spare part number 730539-001.
674318-001	HP USB laser mouse
675794-001	Atheros AR9485 802.11 b/g/n WiFi Adapter for use only on computer models equipped with an AMD processor
679921-001	HP Essential top-load carrying case
679922-001	HP Essential messenger bag style carrying case
679923-001	HP Essential backpack carrying case

Spare part number	Description
683802-001	500-GB, 5400-rpm, SATA, 7.0-mm hard drive for use only on computer models equipped with an Intel processor (does not include hard drive bracket, hard drive connector adapter, or screws)  <b>NOTE:</b> The hard drive bracket, hard drive connector adapter, and screws are included in the Hard Drive Hardware Kit, spare part number 730539-001.
690650-001	HP USB 3.0 port replicator
690652-001	USB 3.0 type A connector to type B connector cable (0.5-m long)
691740-001	4-GB memory module (PCL3, 12800, 1600-MHz)
691922-001	HP comfort-grip wireless mouse
693374-001	4-GB memory module (PCL3, 12800, 1600-MHz)
693710-001	65-W HP Smart adapter (EM, RC/V, 3-wire, 4.5-mm)
693711-001	65-W HP Smart adapter (non-PFC, 3-wire, 4.5-mm)
693716-001	65-W HP Smart travel adapter (non-PFC)
697316-001	Broadcom BCM943228HMB 802.11 a/b/g/n 2x2 Wi-Fi + Bluetooth 4.0 Combo Adapter for use only on computer models equipped with an Intel processor
702853-001	RTC battery (includes cable and double-sided adhesive)
703267-001	500-GB, 7200-rpm, SATA, 7.0-mm hard drive for use on all computer models (does not include hard drive bracket, hard drive connector adapter, or screws)  <b>NOTE:</b> The hard drive bracket, hard drive connector adapter, and screws are included in the Hard Drive Hardware Kit, spare part number 730539-001.
703268-001	500-GB, 7200-rpm, SED, 7.0-mm hard drive for use on all computer models (does not include hard drive bracket, hard drive connector adapter, or screws)  <b>NOTE:</b> The hard drive bracket, hard drive connector adapter, and screws are included in the Hard Drive Hardware Kit, spare part number 730539-001.
703372-001	HP ultraslim keyed cable lock
704030-001	HP It4111 LTE/EV-DO/HSPA+ Mobile Broadband Module for use only on computer models equipped with an Intel processor
704031-001	HP It4112 LTE/HSPA+ Mobile Broadband Module for use only on computer models equipped with an Intel processor
705621-001	HP professional top-load carrying case
710661-001	Intel Dual Band Wireless-AC 7260 802.11 ac 2x2 Wi-Fi + Bluetooth 4.0 WLAN module for use only on computer models equipped with an Intel processor
714749-001	HP Mobile Connect SIM module
717377-001	3-cell, 26-WHr, 2.50-AHr, Li-ion battery
717378-001	3-cell, 46-WHr, 4.15-AHr, Li-ion battery
717381-001	Intel Dual Band Wireless-N 7260AN 802.11 a/b/g/n 2x2 Wi-Fi + Bluetooth 4.0 Combo Adapter for use only on computer models equipped with an Intel processor

<b>Spare part number</b>	<b>Description</b>
717382-001	Intel Dual Band Wireless-N 7260NB 802.11 a/b/g/n 2x2 WiFi adapter for use only on computer models equipped with an Intel processor
718549-001	HP business slim top-load carrying case
718550-001	HP business top-load carrying case
721092-001	45-W HP Smart adapter (non-PFC, RC, 3-wire, 4.5-mm)
723895-001	HP hs3110 HSPA+ Mobile Broadband Module
724935-001	Broadcom BCM4352 802.11 ac 2x2 Wi-Fi + Bluetooth 4.0 Combo Adapter for use only on computer models equipped with an AMD processor
730535-001	12.5-in, AG, HD, LED, SVA non-TouchScreen display panel for use only on computer models equipped with an Intel processor
730536-001	12.5-in, AG, HD, LED, UWVA non-TouchScreen display panel for use only on computer models equipped with an Intel processor
730537-001	Display Cable Kit (includes display panel cable and webcam/microphone module cable)
730538-001	Display Panel Support Kit for use only on computer models equipped with an Intel processor (includes display enclosure, WLAN antenna cables and transceivers, and WWAN antenna cables and transceivers)
730539-001	Hard Drive Hardware Kit (includes hard drive bracket, hard drive connector adapter, and screws)
730540-001	Keyboard with pointing stick for use only on computer models equipped with an Intel processor in the United States (includes keyboard cable)
730540-031	Keyboard with pointing stick for use only on computer models equipped with an Intel processor in the United Kingdom and Singapore (includes keyboard cable)
730540-041	Keyboard with pointing stick for use only on computer models equipped with an Intel processor in France (includes keyboard cable)
730540-051	Keyboard with pointing stick for use only on computer models equipped with an Intel processor in Germany (includes keyboard cable)
730540-061	Keyboard with pointing stick for use only on computer models equipped with an Intel processor in Italy (includes keyboard cable)
730540-071	Keyboard with pointing stick for use only on computer models equipped with an Intel processor in Spain (includes keyboard cable)
730540-081	Keyboard with pointing stick for use only on computer models equipped with an Intel processor in Denmark (includes keyboard cable)
730540-091	Keyboard with pointing stick for use only on computer models equipped with an Intel processor in Norway (includes keyboard cable)
730540-131	Keyboard with pointing stick for use only on computer models equipped with an Intel processor in Portugal (includes keyboard cable)
730540-141	Keyboard with pointing stick for use only on computer models equipped with an Intel processor in Turkey (includes keyboard cable)
730540-151	Keyboard with pointing stick for use only on computer models equipped with an Intel processor in Greece (includes keyboard cable)

<b>Spare part number</b>	<b>Description</b>
730540-161	Keyboard with pointing stick for use only on computer models equipped with an Intel processor in Latin America (includes keyboard cable)
730540-171	Keyboard with pointing stick for use only on computer models equipped with an Intel processor in Saudi Arabia (includes keyboard cable)
730540-201	Keyboard with pointing stick for use only on computer models equipped with an Intel processor in Brazil (includes keyboard cable)
730540-211	Keyboard with pointing stick for use only on computer models equipped with an Intel processor in Hungary (includes keyboard cable)
730540-251	Keyboard with pointing stick for use only on computer models equipped with an Intel processor in Russia (includes keyboard cable)
730540-261	Keyboard with pointing stick for use only on computer models equipped with an Intel processor in Bulgaria (includes keyboard cable)
730540-271	Keyboard with pointing stick for use only on computer models equipped with an Intel processor in Romania (includes keyboard cable)
730540-281	Keyboard with pointing stick for use only on computer models equipped with an Intel processor in Thailand (includes keyboard cable)
730540-291	Keyboard with pointing stick for use only on computer models equipped with an Intel processor in Japan (includes keyboard cable)
730540-A41	Keyboard with pointing stick for use only on computer models equipped with an Intel processor in Belgium (includes keyboard cable)
730540-AB1	Keyboard with pointing stick for use only on computer models equipped with an Intel processor in Taiwan (includes keyboard cable)
730540-AD1	Keyboard with pointing stick for use only on computer models equipped with an Intel processor in South Korea (includes keyboard cable)
730540-B31	Keyboard with pointing stick for use only on computer models equipped with an Intel processor in the Netherlands (includes keyboard cable)
730540-B71	Keyboard with pointing stick for use only on computer models equipped with an Intel processor in Sweden and Finland (includes keyboard cable)
730540-BA1	Keyboard with pointing stick for use only on computer models equipped with an Intel processor in Slovenia (includes keyboard cable)
730540-BB1	Keyboard with pointing stick for use only on computer models equipped with an Intel processor in Israel (includes keyboard cable)
730540-BG1	Keyboard with pointing stick for use only on computer models equipped with an Intel processor in Switzerland (includes keyboard cable)
730540-D61	Keyboard with pointing stick for use only on computer models equipped with an Intel processor in India (includes keyboard cable)
730540-DB1	Keyboard with pointing stick for use only on computer models equipped with an Intel processor in Canada (includes keyboard cable)
730540-DD1	Keyboard with pointing stick for use only on computer models equipped with an Intel processor in Iceland (includes keyboard cable)

<b>Spare part number</b>	<b>Description</b>
730540-FL1	Keyboard with pointing stick for use only on computer models equipped with an Intel processor in the Czech Republic and Slovakia (includes keyboard cable)
730540-FP1	Keyboard with pointing stick for use only on computer models equipped with an Intel processor in Northwest Africa (includes keyboard cable)
730541-001	Keyboard with backlight and pointing stick for use only on computer models equipped with an Intel processor in the United States (includes backlight cable and keyboard cable)
730541-031	Keyboard with backlight and pointing stick for use only on computer models equipped with an Intel processor in the United Kingdom and Singapore (includes backlight cable and keyboard cable)
730541-041	Keyboard with backlight and pointing stick for use only on computer models equipped with an Intel processor in France (includes backlight cable and keyboard cable)
730541-051	Keyboard with backlight and pointing stick for use only on computer models equipped with an Intel processor in Germany (includes backlight cable and keyboard cable)
730541-061	Keyboard with backlight and pointing stick for use only on computer models equipped with an Intel processor in Italy (includes backlight cable and keyboard cable)
730541-071	Keyboard with backlight and pointing stick for use only on computer models equipped with an Intel processor in Spain (includes backlight cable and keyboard cable)
730541-081	Keyboard with backlight and pointing stick for use only on computer models equipped with an Intel processor in Denmark (includes backlight cable and keyboard cable)
730541-091	Keyboard with backlight and pointing stick for use only on computer models equipped with an Intel processor in Norway (includes backlight cable and keyboard cable)
730541-131	Keyboard with backlight and pointing stick for use only on computer models equipped with an Intel processor in Portugal (includes backlight cable and keyboard cable)
730541-141	Keyboard with backlight and pointing stick for use only on computer models equipped with an Intel processor in Turkey (includes backlight cable and keyboard cable)
730541-151	Keyboard with backlight and pointing stick for use only on computer models equipped with an Intel processor in Greece (includes backlight cable and keyboard cable)
730541-161	Keyboard with backlight and pointing stick for use only on computer models equipped with an Intel processor in Latin America (includes backlight cable and keyboard cable)
730541-171	Keyboard with backlight and pointing stick for use only on computer models equipped with an Intel processor in Saudi Arabia (includes backlight cable and keyboard cable)
730541-201	Keyboard with backlight and pointing stick for use only on computer models equipped with an Intel processor in Brazil (includes backlight cable and keyboard cable)
730541-211	Keyboard with backlight and pointing stick for use only on computer models equipped with an Intel processor in Hungary (includes backlight cable and keyboard cable)
730541-251	Keyboard with backlight and pointing stick for use only on computer models equipped with an Intel processor in Russia (includes backlight cable and keyboard cable)
730541-261	Keyboard with backlight and pointing stick for use only on computer models equipped with an Intel processor in Bulgaria (includes backlight cable and keyboard cable)
730541-271	Keyboard with backlight and pointing stick for use only on computer models equipped with an Intel processor in Romania (includes backlight cable and keyboard cable)

<b>Spare part number</b>	<b>Description</b>
730541-281	Keyboard with backlight and pointing stick for use only on computer models equipped with an Intel processor in Thailand (includes backlight cable and keyboard cable)
730541-291	Keyboard with backlight and pointing stick for use only on computer models equipped with an Intel processor in Japan (includes backlight cable and keyboard cable)
730541-A41	Keyboard with backlight and pointing stick for use only on computer models equipped with an Intel processor in Belgium (includes backlight cable and keyboard cable)
730541-AB1	Keyboard with backlight and pointing stick for use only on computer models equipped with an Intel processor in Taiwan (includes backlight cable and keyboard cable)
730541-AD1	Keyboard with backlight and pointing stick for use only on computer models equipped with an Intel processor in South Korea (includes backlight cable and keyboard cable)
730541-B31	Keyboard with backlight and pointing stick for use only on computer models equipped with an Intel processor in the Netherlands (includes backlight cable and keyboard cable)
730541-B71	Keyboard with backlight and pointing stick for use only on computer models equipped with an Intel processor in Sweden and Finland (includes backlight cable and keyboard cable)
730541-BA1	Keyboard with backlight and pointing stick for use only on computer models equipped with an Intel processor in Slovenia (includes backlight cable and keyboard cable)
730541-BB1	Keyboard with backlight and pointing stick for use only on computer models equipped with an Intel processor in Israel (includes backlight cable and keyboard cable)
730541-BG1	Keyboard with backlight and pointing stick for use only on computer models equipped with an Intel processor in Switzerland (includes backlight cable and keyboard cable)
730541-D61	Keyboard with backlight and pointing stick for use only on computer models equipped with an Intel processor in India (includes backlight cable and keyboard cable)
730541-DB1	Keyboard with backlight and pointing stick for use only on computer models equipped with an Intel processor in Canada (includes backlight cable and keyboard cable)
730541-DD1	Keyboard with backlight and pointing stick for use only on computer models equipped with an Intel processor in Iceland (includes backlight cable and keyboard cable)
730541-FL1	Keyboard with backlight and pointing stick for use only on computer models equipped with an Intel processor in the Czech Republic and Slovakia (includes backlight cable and keyboard cable)
730541-FP1	Keyboard with backlight and pointing stick for use only on computer models equipped with an Intel processor in Northwest Africa (includes backlight cable and keyboard cable)
730542-001	Webcam/microphone module for use only on computer models equipped with an Intel processor (includes double-sided adhesive)
730543-001	Display Hinge Kit for use only on computer models equipped with an Intel processor (includes left and right hinges and hinge brackets)
730544-001	Display bezel for use only on computer models equipped with an Intel processor
730547-001	Fan for use only on computer models equipped with an Intel processor (includes cable)
730548-001	Top cover for use only on computer models equipped with an Intel processor
730549-001	TouchPad (includes cable)
730550-001	Rubber Kit (includes base enclosure rubber screw covers)

<b>Spare part number</b>	<b>Description</b>
730551-001	Base enclosure for use only on computer models equipped with an Intel processor (includes RJ-45 cover, rubber feet, and service cover eject latch assembly)
730552-001	Power button board (includes cable)
730553-001	Screw Kit
730554-001	Fingerprint reader board (includes bracket and cable)
730555-001	Speaker assembly (includes left and right speakers and cables)
730556-001	Heat sink for use only on computer models equipped with an Intel processor (includes replacement thermal material)
730557-001	System board equipped with an Intel Core i3-4010U 1.70-GHz processor (3.00-MB L3 cache, 15 W), a graphics subsystem with UMA memory, and a non-Windows 8 operating system for use only on computer models equipped with a non-TouchScreen display assembly (includes replacement thermal material)
730557-501	System board equipped with an Intel Core i3-4010U 1.70-GHz processor (3.00-MB L3 cache, 15 W), a graphics subsystem with UMA memory, and the Windows 8 Standard operating system for use only on computer models equipped with a non-TouchScreen display assembly (includes replacement thermal material)
730557-601	System board equipped with an Intel Core i3-4010U 1.70-GHz processor (3.00-MB L3 cache, 15 W), a graphics subsystem with UMA memory, and the Windows 8 Professional operating system for use only on computer models equipped with a non-TouchScreen display assembly (includes replacement thermal material)
730558-001	System board equipped with an Intel Core i5-4200U 1.60-GHz (SC turbo up to 2.60-GHz) processor (3.00-MB L3 cache, 15 W), a graphics subsystem with UMA memory, and a non-Windows 8 operating system for use only on computer models equipped with a non-TouchScreen display assembly (includes replacement thermal material)
730558-501	System board equipped with an Intel Core i5-4200U 1.60-GHz (SC turbo up to 2.60-GHz) processor (3.00-MB L3 cache, 15 W), a graphics subsystem with UMA memory, and the Windows 8 Standard operating system for use only on computer models equipped with a non-TouchScreen display assembly (includes replacement thermal material)
730558-601	System board equipped with an Intel Core i5-4200U 1.60-GHz (SC turbo up to 2.60-GHz) processor (3.00-MB L3 cache, 15 W), a graphics subsystem with UMA memory, and the Windows 8 Professional operating system for use only on computer models equipped with a non-TouchScreen display assembly (includes replacement thermal material)
730559-001	System board equipped with an Intel Core i7-4600U 2.10-GHz (SC turbo up to 3.30-GHz) processor (4.00-MB L3 cache, 15 W), a graphics subsystem with UMA memory, and a non-Windows 8 operating system for use only on computer models equipped with a non-TouchScreen display assembly (includes replacement thermal material)
730559-501	System board equipped with an Intel Core i7-4600U 2.10-GHz (SC turbo up to 3.30-GHz) processor (4.00-MB L3 cache, 15 W), a graphics subsystem with UMA memory, and the Windows 8 Standard operating system for use only on computer models equipped with a non-TouchScreen display assembly (includes replacement thermal material)
730559-601	System board equipped with an Intel Core i7-4600U 2.10-GHz (SC turbo up to 3.30-GHz) processor (4.00-MB L3 cache, 15 W), a graphics subsystem with UMA memory, and the Windows 8 Professional operating system for use only on computer models equipped with a non-TouchScreen display assembly (includes replacement thermal material)



Spare part number	Description
730560-001	Antenna Kit for use only on computer models equipped with an Intel processor (includes WLAN antenna cables and transceivers and WWAN antenna cables and transceivers)
730561-001	Display enclosure for use only on computer models equipped with an Intel processor
730562-001	Plastics Kit
730563-001	Card reader board (includes cable)
730564-001	Service cover with CCCO mark for use only on computer models equipped with an Intel processor (includes rubber feet)
730565-001	180-GB, SATA-3 solid-state drive for use only on computer models equipped with an Intel processor
730566-001	240-GB, SATA-3 solid-state drive for use only on computer models equipped with an Intel processor
730567-001	256-GB, SATA-3, SED solid-state drive for use only on computer models equipped with an Intel processor
730568-001	120-GB, mSATA-3 solid-state drive for use only on computer models equipped with an Intel processor
730668-001	Broadcom BCM943228HMB 802.11 abgn 2x2 Wi-Fi Adapter, Broadcom Bluetooth 4.0 Adapter for use only on computer models equipped with an AMD processor
730795-001	Microphone module
730946-001	500-GB, 5400-rpm, SATA, FIPS 7.0-mm hard drive for use on all computer models (does not include hard drive bracket, hard drive connector adapter, or screws)  <b>NOTE:</b> The hard drive bracket, hard drive connector adapter, and screws are included in the Hard Drive Hardware Kit, spare part number 730539-001.
731066-001	System board equipped with an Intel Core i5-4300U 1.90-GHz (SC turbo up to 2.90-GHz) processor (3.00-MB L3 cache, 15 W), a graphics subsystem with UMA memory, and a non-Windows 8 operating system for use only on computer models equipped with a non-TouchScreen display assembly (includes replacement thermal material)
731066-501	System board equipped with an Intel Core i5-4300U 1.90-GHz (SC turbo up to 2.90-GHz) processor (3.00-MB L3 cache, 15 W), a graphics subsystem with UMA memory, and the Windows 8 Standard operating system for use only on computer models equipped with a non-TouchScreen display assembly (includes replacement thermal material)
731066-601	System board equipped with an Intel Core i5-4300U 1.90-GHz (SC turbo up to 2.90-GHz) processor (3.00-MB L3 cache, 15 W), a graphics subsystem with UMA memory, and the Windows 8 Professional operating system for use only on computer models equipped with a non-TouchScreen display assembly (includes replacement thermal material)
732252-001	HP 2013 UltraSlim Docking Station
736675-001	HP lt4226 LTE/HSPA+4G Module for use only on computer models equipped with an Intel processor
736676-001	HP lt4225 LTE/EV-DO4G Module for use only on computer models equipped with an Intel processor
740011-001	HP lt4112 LTE/HSPA+ Mobile Broadband Module for use only on computer models equipped with an AMD processor
742437-001	45-W HP Smart adapter (non-PFC, RC, 2-wire, 4.5-mm)
743008-001	32-GB, SATA-3 solid-state drive for use only on computer models equipped with an Intel processor

<b>Spare part number</b>	<b>Description</b>
744716-001	128-GB, SATA-3 solid-state drive for use only on computer models equipped with an Intel processor
744893-001	45-W HP Smart adapter (non-PFC, RC, 7.4-mm)
745308-001	Service cover for use only on computer models equipped with an Intel processor and non-TouchScreen display assembly (includes rubber feet)
747832-001	Intel Dual Band Wireless-N 7260AN 802.11 a/b/g/n 2x2 WiFi + Bluetooth 4.0 Combo Adapter for use only on computer models equipped with an Intel processor
748021-001	HP It4111 LTE/EV-DO/HSPA+ Mobile Broadband Module for use only on computer models equipped with an AMD processor
748599-001	HP hs3110 HSPA+ Mobile Broadband Module for use only on computer models equipped with an AMD processor
749288-001	HP DisplayPort-to-HDMI 1.4 adapter
752103-001	512-GB, SATA-3 solid-state drive for use only on computer models equipped with an Intel processor
753071-001	System board equipped with an Intel Core i7-4500U 1.80-GHz (SC turbo up to 3.00-GHz) processor (4.00-MB L3 cache, 15 W), a graphics subsystem with UMA memory, and a non-Windows 8 Professional operating system for use only on computer models equipped with a non-TouchScreen display assembly (includes replacement thermal material)
753071-501	System board equipped with an Intel Core i7-4500U 1.80-GHz (SC turbo up to 3.00-GHz) processor (4.00-MB L3 cache, 15 W), a graphics subsystem with UMA memory, and the Windows 8 Standard operating system for use only on computer models equipped with a non-TouchScreen display assembly (includes replacement thermal material)
753071-601	System board equipped with an Intel Core i7-4500U 1.80-GHz (SC turbo up to 3.00-GHz) processor (4.00-MB L3 cache, 15 W), a graphics subsystem with UMA memory, and the Windows 8 Professional operating system for use only on computer models equipped with a non-TouchScreen display assembly (includes replacement thermal material)
755530-001	Power cord for use in North America (3-pin, black, 1.00-m)
755530-011	Power cord for use in Australia (3-pin, black, 1.00-m)
755530-021	Power cord for use in Europe (3-pin, black, 1.00-m)
755530-031	Power cord for use in the United Kingdom and Singapore (3-pin, black, 1.00-m)
755530-061	Power cord for use in Italy (3-pin, black, 1.00-m)
755530-081	Power cord for use in Denmark (3-pin, black, 1.00-m)
755530-111	Power cord for use in Switzerland (3-pin, black, 1.00-m)
755530-201	Power cord for use in Thailand (3-pin, black, 1.00-m)
755530-202	Power cord for use in Brazil (3-pin, black, 1.00-m)
755530-291	Power cord for use in Japan (3-pin, black, 1.00-m)
755530-AA1	Power cord for use in the People's Republic of China (3-pin, black, 1.00-m)
755530-AB1	Power cord for use in Taiwan (3-pin, black, 1.00-m)
755530-AD1	Power cord for use in South Korea (3-pin, black, 1.00-m)
755530-AR1	Power cord for use in South Africa (3-pin, black, 1.00-m)

<b>Spare part number</b>	<b>Description</b>
755530-BB1	Power cord for use in Israel (3-pin, black, 1.00-m)
755530-D01	Power cord for use in Argentina (3-pin, black, 1.00-m)
755530-D61	Power cord for use in India (3-pin, black, 1.00-m)
761774-001	System board equipped with an Intel Core i3-4010U 1.70-GHz processor (3.00-MB L3 cache, 15 W), a graphics subsystem with UMA memory, and a non-Windows 8 operating system for use only on computer models equipped with a TouchScreen display assembly (includes replacement thermal material)
761774-501	System board equipped with an Intel Core i3-4010U 1.70-GHz processor (3.00-MB L3 cache, 15 W), a graphics subsystem with UMA memory, and the Windows 8 Standard operating system for use only on computer models equipped with a TouchScreen display assembly (includes replacement thermal material)
761774-601	System board equipped with an Intel Core i3-4010U 1.70-GHz processor (3.00-MB L3 cache, 15 W), a graphics subsystem with UMA memory, and the Windows 8 Professional operating system for use only on computer models equipped with a TouchScreen display assembly (includes replacement thermal material)
761775-001	System board equipped with an Intel Core i5-4200U 1.60-GHz (SC turbo up to 2.60-GHz) processor (3.00-MB L3 cache, 15 W), a graphics subsystem with UMA memory, and a non-Windows 8 operating system for use only on computer models equipped with a TouchScreen display assembly (includes replacement thermal material)
761775-501	System board equipped with an Intel Core i5-4200U 1.60-GHz (SC turbo up to 2.60-GHz) processor (3.00-MB L3 cache, 15 W), a graphics subsystem with UMA memory, and the Windows 8 Standard operating system for use only on computer models equipped with a TouchScreen display assembly (includes replacement thermal material)
761775-601	System board equipped with an Intel Core i5-4200U 1.60-GHz (SC turbo up to 2.60-GHz) processor (3.00-MB L3 cache, 15 W), a graphics subsystem with UMA memory, and the Windows 8 Professional operating system for use only on computer models equipped with a TouchScreen display assembly (includes replacement thermal material)
761776-001	System board equipped with an Intel Core i5-4300U 1.90-GHz (SC turbo up to 2.90-GHz) processor (3.00-MB L3 cache, 15 W), a graphics subsystem with UMA memory, and a non-Windows 8 operating system for use only on computer models equipped with a TouchScreen display assembly (includes replacement thermal material)
761776-501	System board equipped with an Intel Core i5-4300U 1.90-GHz (SC turbo up to 2.90-GHz) processor (3.00-MB L3 cache, 15 W), a graphics subsystem with UMA memory, and the Windows 8 Standard operating system for use only on computer models equipped with a TouchScreen display assembly (includes replacement thermal material)
761776-601	System board equipped with an Intel Core i5-4300U 1.90-GHz (SC turbo up to 2.90-GHz) processor (3.00-MB L3 cache, 15 W), a graphics subsystem with UMA memory, and the Windows 8 Professional operating system for use only on computer models equipped with a TouchScreen display assembly (includes replacement thermal material)
761777-001	System board equipped with an Intel Core i7-4500U 1.80-GHz (SC turbo up to 3.00-GHz) processor (4.00-MB L3 cache, 15 W), a graphics subsystem with UMA memory, and a non-Windows 8 operating system for use only on computer models equipped with a TouchScreen display assembly (includes replacement thermal material)
761777-501	System board equipped with an Intel Core i7-4500U 1.80-GHz (SC turbo up to 3.00-GHz) processor (4.00-MB L3 cache, 15 W), a graphics subsystem with UMA memory, and the Windows 8 Standard operating system for use only on computer models equipped with a TouchScreen display assembly (includes replacement thermal material)

Spare part number	Description
761777-601	System board equipped with an Intel Core i7-4500U 1.80-GHz (SC turbo up to 3.00-GHz) processor (4.00-MB L3 cache, 15 W), a graphics subsystem with UMA memory, and the Windows 8 Professional operating system for use only on computer models equipped with a TouchScreen display assembly (includes replacement thermal material)
761778-001	System board equipped with an Intel Core i7-4600U 2.10-GHz (SC turbo up to 3.10-GHz) processor (4.00-MB L3 cache, 15 W), a graphics subsystem with UMA memory, and a non-Windows 8 operating system for use only on computer models equipped with a TouchScreen display assembly (includes replacement thermal material)
761778-501	System board equipped with an Intel Core i7-4600U 2.10-GHz (SC turbo up to 3.10-GHz) processor (4.00-MB L3 cache, 15 W), a graphics subsystem with UMA memory, and the Windows 8 Standard operating system for use only on computer models equipped with a TouchScreen display assembly (includes replacement thermal material)
761778-601	System board equipped with an Intel Core i7-4600U 2.10-GHz (SC turbo up to 3.10-GHz) processor (4.00-MB L3 cache, 15 W), a graphics subsystem with UMA memory, and the Windows 8 Professional operating system for use only on computer models equipped with a TouchScreen display assembly (includes replacement thermal material)
761780-001	Service cover for use only on computer models equipped with an Intel processor and TouchScreen display assembly (includes rubber feet)
761781-001	12.5-in, AG, HD, LED, UWVA, TouchScreen display assembly for use only on computer models equipped with an Intel processor
761906-001	256-GB, SATA-3, SED, Opal 2, solid-state drive for use only on computer models equipped with an Intel processor
762689-291	Power cord for use in Japan (2-pin, black, 1.00-m)
762990-001	1-TB, 5400-rpm, 7.0-mm hard drive for use only on computer models equipped with an AMD processor (does not include hard drive bracket, hard drive connector adapter, or screws)  <b>NOTE:</b> The hard drive bracket, hard drive connector adapter, and screws are included in the Hard Drive Hardware Kit, spare part number 730539-001.
763522-001	500-GB, 5400-rpm, SATA, locked, 7.0-mm hard drive for use only on computer models equipped with an Intel processor (does not include hard drive bracket, hard drive connector adapter, or screws)  <b>NOTE:</b> The hard drive bracket, hard drive connector adapter, and screws are included in the Hard Drive Hardware Kit, spare part number 730539-001.
764507-001	128-GB, SATA-3, locked, Opal 2, solid-state drive for use only on computer models equipped with an Intel processor
765603-001	Base enclosure for use only on computer models equipped with an AMD processor (includes RJ-45 cover, rubber feet, and service cover eject latch assembly)
765605-001	Heat sink for use only on computer models equipped with an AMD processor (includes replacement thermal material)
765606-001	12.5-in, AG, FHD, LED, UWVA, TouchScreen display assembly for use only on computer models equipped with an AMD processor
765607-001	12.5-in, AG, FHD, LED, SVA non-TouchScreen display panel for use only on computer models equipped with an AMD processor
765609-001	128-GB, SATA-3 solid-state drive for use only on computer models equipped with an AMD processor

<b>Spare part number</b>	<b>Description</b>
765610-001	180-GB, SATA-3 solid-state drive for use only on computer models equipped with an AMD processor
765611-001	180-GB, SATA-3, SED, OPAL-1 solid-state drive for use only on computer models equipped with an AMD processor
765612-001	240-GB, SATA-3 solid-state drive for use only on computer models equipped with an AMD processor
765613-001	256-GB, SATA-3, SED, OPAL-1 solid-state drive for use only on computer models equipped with an AMD processor
765614-001	256-GB, SATA-3, SED, OPAL-2 solid-state drive for use only on computer models equipped with an AMD processor
765615-001	System board equipped with an AMD A6 Pro-7050B 2.20-GHz (SC turbo up to 3.00-GHz) dual core processor (1.00-MB L2 cache, 17 W), a graphics subsystem with UMA memory, and a non-Windows 8 operating system (includes replacement thermal material)
765615-501	System board equipped with an AMD A6 Pro-7050B 2.20-GHz (SC turbo up to 3.00-GHz) dual core processor (1.00-MB L2 cache, 17 W), a graphics subsystem with UMA memory, and the Windows 8 Standard operating system (includes replacement thermal material)
765615-601	System board equipped with an AMD A6 Pro-7050B 2.20-GHz (SC turbo up to 3.00-GHz) dual core processor (1.00-MB L2 cache, 17 W), a graphics subsystem with UMA memory, and the Windows 8 Professional operating system (includes replacement thermal material)
765616-001	System board equipped with an AMD A8 Pro-7150B 2.00-GHz (SC turbo up to 3.20-GHz) quad core processor (4.00-MB L2 cache, 19 W), a graphics subsystem with UMA memory, and a non-Windows 8 operating system (includes replacement thermal material)
765616-501	System board equipped with an AMD A8 Pro-7150B 2.00-GHz (SC turbo up to 3.20-GHz) quad core processor (4.00-MB L2 cache, 19 W), a graphics subsystem with UMA memory, and the Windows 8 Standard operating system (includes replacement thermal material)
765616-601	System board equipped with an AMD A8 Pro-7150B 2.00-GHz (SC turbo up to 3.20-GHz) quad core processor (4.00-MB L2 cache, 19 W), a graphics subsystem with UMA memory, and the Windows 8 Professional operating system (includes replacement thermal material)
765617-001	System board equipped with an AMD A10 Pro-7350B 2.10-GHz (SC turbo up to 3.30-GHz) quad core processor (4.00-MB L2 cache, 19 W), a graphics subsystem with UMA memory, and a non-Windows 8 operating system (includes replacement thermal material)
765617-501	System board equipped with an AMD A10 Pro-7350B 2.10-GHz (SC turbo up to 3.30-GHz) quad core processor (4.00-MB L2 cache, 19 W), a graphics subsystem with UMA memory, and the Windows 8 Standard operating system (includes replacement thermal material)
765617-601	System board equipped with an AMD A10 Pro-7350B 2.10-GHz (SC turbo up to 3.30-GHz) quad core processor (4.00-MB L2 cache, 19 W), a graphics subsystem with UMA memory, and the Windows 8 Professional operating system (includes replacement thermal material)
766012-001	Display bezel for use only on computer models equipped with an AMD processor
766018-001	Service cover for use only on computer models equipped with an AMD processor (includes rubber feet)
766679-001	128-GB, SATA-3, locked, solid-state drive for use only on computer models equipped with an Intel processor
775247-001	180-GB, SATA-3, SED, Opal 1, solid-state drive for use only on computer models equipped with an Intel processor

<b>Spare part number</b>	<b>Description</b>
775893-001	Display enclosure for use only on computer models equipped with an AMD processor
775894-001	Antenna Kit for use only on computer models equipped with an AMD processor (WLAN antenna cables and transceivers and WWAN antenna cables and transceivers)
775895-001	Display Hinge Kit for use only on computer models equipped with an AMD processor (includes left and right hinges and hinge brackets)
775896-001	Display bezel for use only on computer models equipped with an AMD processor
775897-001	Display Panel Support Kit for use only on computer models equipped with an AMD processor (includes display enclosure, WLAN antenna cables and transceivers, and WWAN antenna cables and transceivers)
776451-001	Keyboard with pointing stick for use only on computer models equipped with an AMD processor in the United States (includes keyboard cable)
776451-031	Keyboard with pointing stick for use only on computer models equipped with an AMD processor in the United Kingdom (includes keyboard cable)
776451-041	Keyboard with pointing stick for use only on computer models equipped with an AMD processor in Germany (includes keyboard cable)
776451-051	Keyboard with pointing stick for use only on computer models equipped with an AMD processor in France (includes keyboard cable)
776451-061	Keyboard with pointing stick for use only on computer models equipped with an AMD processor in Italy (includes keyboard cable)
776451-071	Keyboard with pointing stick for use only on computer models equipped with an AMD processor in Spain (includes keyboard cable)
776451-081	Keyboard with pointing stick for use only on computer models equipped with an AMD processor in Denmark (includes keyboard cable)
776451-091	Keyboard with pointing stick for use only on computer models equipped with an AMD processor in Norway (includes keyboard cable)
776451-131	Keyboard with pointing stick for use only on computer models equipped with an AMD processor in Portugal (includes keyboard cable)
776451-141	Keyboard with pointing stick for use only on computer models equipped with an AMD processor in Turkey (includes keyboard cable)
776451-151	Keyboard with pointing stick for use only on computer models equipped with an AMD processor in Greece (includes keyboard cable)
776451-161	Keyboard with pointing stick for use only on computer models equipped with an AMD processor in Latin America (includes keyboard cable)
776451-171	Keyboard with pointing stick for use only on computer models equipped with an AMD processor in Saudi Arabia (includes keyboard cable)
776451-201	Keyboard with pointing stick for use only on computer models equipped with an AMD processor in Brazil (includes keyboard cable)
776451-211	Keyboard with pointing stick for use only on computer models equipped with an AMD processor in Hungary (includes keyboard cable)
776451-251	Keyboard with pointing stick for use only on computer models equipped with an AMD processor in Russia (includes keyboard cable)

<b>Spare part number</b>	<b>Description</b>
776451-261	Keyboard with pointing stick for use only on computer models equipped with an AMD processor in Bulgaria (includes keyboard cable)
776451-271	Keyboard with pointing stick for use only on computer models equipped with an AMD processor in Romania (includes keyboard cable)
776451-281	Keyboard with pointing stick for use only on computer models equipped with an AMD processor in Thailand (includes keyboard cable)
776451-291	Keyboard with pointing stick for use only on computer models equipped with an AMD processor in Japan (includes keyboard cable)
776451-A41	Keyboard with pointing stick for use only on computer models equipped with an AMD processor in Belgium (includes keyboard cable)
776451-AB1	Keyboard with pointing stick for use only on computer models equipped with an AMD processor in Taiwan (includes keyboard cable)
776451-AD1	Keyboard with pointing stick for use only on computer models equipped with an AMD processor in South Korea (includes keyboard cable)
776451-B31	Keyboard with pointing stick for use only on computer models equipped with an AMD processor in the Netherlands (includes keyboard cable)
776451-B71	Keyboard with pointing stick for use only on computer models equipped with an AMD processor in Sweden and Finland (includes keyboard cable)
776451-BA1	Keyboard with pointing stick for use only on computer models equipped with an AMD processor in Slovenia (includes keyboard cable)
776451-BB1	Keyboard with pointing stick for use only on computer models equipped with an AMD processor in Israel (includes keyboard cable)
776451-BG1	Keyboard with pointing stick for use only on computer models equipped with an AMD processor in Switzerland (includes keyboard cable)
776451-D61	Keyboard with pointing stick for use only on computer models equipped with an AMD processor in India (includes keyboard cable)
776451-DB1	Keyboard with pointing stick for use only on computer models equipped with an AMD processor in Canada (includes keyboard cable)
776451-DD1	Keyboard with pointing stick for use only on computer models equipped with an AMD processor in Iceland (includes keyboard cable)
776451-FL1	Keyboard with pointing stick for use only on computer models equipped with an AMD processor in the Czech Republic and Slovakia (includes keyboard cable)
776451-FP1	Keyboard with pointing stick for use only on computer models equipped with an AMD processor in Northwest Africa (includes keyboard cable)
776452-001	Keyboard with backlight and pointing stick for use only on computer models equipped with an AMD processor in the United States (includes backlight cable and keyboard cable)
776452-031	Keyboard with backlight and pointing stick for use only on computer models equipped with an AMD processor in the United Kingdom (includes backlight cable and keyboard cable)
776452-041	Keyboard with backlight and pointing stick for use only on computer models equipped with an AMD processor in Germany (includes backlight cable and keyboard cable)

<b>Spare part number</b>	<b>Description</b>
776452-051	Keyboard with backlight and pointing stick for use only on computer models equipped with an AMD processor in France (includes backlight cable and keyboard cable)
776452-061	Keyboard with backlight and pointing stick for use only on computer models equipped with an AMD processor in Italy (includes backlight cable and keyboard cable)
776452-071	Keyboard with backlight and pointing stick for use only on computer models equipped with an AMD processor in Spain (includes backlight cable and keyboard cable)
776452-081	Keyboard with backlight and pointing stick for use only on computer models equipped with an AMD processor in Denmark (includes backlight cable and keyboard cable)
776452-091	Keyboard with backlight and pointing stick for use only on computer models equipped with an AMD processor in Norway (includes backlight cable and keyboard cable)
776452-131	Keyboard with backlight and pointing stick for use only on computer models equipped with an AMD processor in Portugal (includes backlight cable and keyboard cable)
776452-141	Keyboard with backlight and pointing stick for use only on computer models equipped with an AMD processor in Turkey (includes backlight cable and keyboard cable)
776452-151	Keyboard with backlight and pointing stick for use only on computer models equipped with an AMD processor in Greece (includes backlight cable and keyboard cable)
776452-161	Keyboard with backlight and pointing stick for use only on computer models equipped with an AMD processor in Latin America (includes backlight cable and keyboard cable)
776452-171	Keyboard with backlight and pointing stick for use only on computer models equipped with an AMD processor in Saudi Arabia (includes backlight cable and keyboard cable)
776452-201	Keyboard with backlight and pointing stick for use only on computer models equipped with an AMD processor in Brazil (includes backlight cable and keyboard cable)
776452-211	Keyboard with backlight and pointing stick for use only on computer models equipped with an AMD processor in Hungary (includes backlight cable and keyboard cable)
776452-251	Keyboard with backlight and pointing stick for use only on computer models equipped with an AMD processor in Russia (includes backlight cable and keyboard cable)
776452-271	Keyboard with backlight and pointing stick for use only on computer models equipped with an AMD processor in Romania (includes backlight cable and keyboard cable)
776452-281	Keyboard with backlight and pointing stick for use only on computer models equipped with an AMD processor in Thailand (includes backlight cable and keyboard cable)
776452-291	Keyboard with backlight and pointing stick for use only on computer models equipped with an AMD processor in Japan (includes backlight cable and keyboard cable)
776452-A41	Keyboard with backlight and pointing stick for use only on computer models equipped with an AMD processor in Belgium (includes backlight cable and keyboard cable)
776452-AB1	Keyboard with backlight and pointing stick for use only on computer models equipped with an AMD processor in Taiwan (includes backlight cable and keyboard cable)
776452-AD1	Keyboard with backlight and pointing stick for use only on computer models equipped with an AMD processor in South Korea (includes backlight cable and keyboard cable)
776452-BA1	Keyboard with backlight and pointing stick for use only on computer models equipped with an AMD processor in Bulgaria (includes backlight cable and keyboard cable)



Spare part number	Description
776452-B31	Keyboard with backlight and pointing stick for use only on computer models equipped with an AMD processor in the Netherlands (includes backlight cable and keyboard cable)
776452-B71	Keyboard with backlight and pointing stick for use only on computer models equipped with an AMD processor in Sweden and Finland (includes backlight cable and keyboard cable)
776452-BA1	Keyboard with backlight and pointing stick for use only on computer models equipped with an AMD processor in Slovenia (includes backlight cable and keyboard cable)
776452-BB1	Keyboard with backlight and pointing stick for use only on computer models equipped with an AMD processor in Israel (includes backlight cable and keyboard cable)
776452-BG1	Keyboard with backlight and pointing stick for use only on computer models equipped with an AMD processor in Switzerland (includes backlight cable and keyboard cable)
776452-D61	Keyboard with backlight and pointing stick for use only on computer models equipped with an AMD processor in India (includes backlight cable and keyboard cable)
776452-DB1	Keyboard with backlight and pointing stick for use only on computer models equipped with an AMD processor in Canada (includes backlight cable and keyboard cable)
776452-DD1	Keyboard with backlight and pointing stick for use only on computer models equipped with an AMD processor in Iceland (includes backlight cable and keyboard cable)
776452-FL1	Keyboard with backlight and pointing stick for use only on computer models equipped with an AMD processor in the Czech Republic and Slovakia (includes backlight cable and keyboard cable)
776626-001	500-GB, 5400-rpm, SATA, locked, 7.0-mm hard drive for use only on computer models equipped with an Intel processor (does not include hard drive bracket, hard drive connector adapter, or screws)  <b>NOTE:</b> The hard drive bracket, hard drive connector adapter, and screws are included in the Hard Drive Hardware Kit, spare part number 730539-001.
776930-001	12.5-in, AG, FHD, LED, SVA TouchScreen display panel for use only on computer models equipped with an AMD processor
777832-001	256-GB, SATA-3, SED, OPAL-2 solid-state drive for use only on computer models equipped with an Intel processor
778828-001	System board equipped with an Intel Core i3-4030U 1.90-GHz processor (3.00-MB L3 cache, 15 W), a graphics subsystem with UMA memory, and a non-Windows 8 operating system (includes replacement thermal material)
778828-501	System board equipped with an Intel Core i3-4030U 1.90-GHz processor (3.00-MB L3 cache, 15 W), a graphics subsystem with UMA memory, and the Windows 8 Standard operating system (includes replacement thermal material)
778828-601	System board equipped with an Intel Core i3-4030U 1.90-GHz processor (3.00-MB L3 cache, 15 W), a graphics subsystem with UMA memory, and the Windows 8 Professional operating system (includes replacement thermal material)
778829-001	System board equipped with an Intel Core i5-4210U 1.70-GHz (SC turbo up to 2.70-GHz) processor (3.00-MB L3 cache, 15 W), a graphics subsystem with UMA memory, and a non-Windows 8 operating system (includes replacement thermal material)
778829-501	System board equipped with an Intel Core i5-4210U 1.70-GHz (SC turbo up to 2.70-GHz) processor (3.00-MB L3 cache, 15 W), a graphics subsystem with UMA memory, and the Windows 8 Standard operating system (includes replacement thermal material)

<b>Spare part number</b>	<b>Description</b>
778829-601	System board equipped with an Intel Core i5-4210U 1.70-GHz (SC turbo up to 2.70-GHz) processor (3.00-MB L3 cache, 15 W), a graphics subsystem with UMA memory, and the Windows 8 Professional operating system (includes replacement thermal material)
778830-001	System board equipped with an Intel Core i5-4310U 2.00-GHz (SC turbo up to 3.00-GHz) processor (3.00-MB L3 cache, 15 W), a graphics subsystem with UMA memory, and a non-Windows 8 operating system (includes replacement thermal material)
778830-501	System board equipped with an Intel Core i5-4310U 2.00-GHz (SC turbo up to 3.00-GHz) processor (3.00-MB L3 cache, 15 W), a graphics subsystem with UMA memory, and the Windows 8 Standard operating system (includes replacement thermal material)
778830-601	System board equipped with an Intel Core i5-4310U 2.00-GHz (SC turbo up to 3.00-GHz) processor (3.00-MB L3 cache, 15 W), a graphics subsystem with UMA memory, and the Windows 8 Professional operating system (includes replacement thermal material)
778831-001	System board equipped with an Intel Core i7-4510U 2.00-GHz (SC turbo up to 3.10-GHz) processor (4.00-MB L3 cache, 15 W), a graphics subsystem with UMA memory, and a non-Windows 8 operating system (includes replacement thermal material)
778831-501	System board equipped with an Intel Core i7-4510U 2.00-GHz (SC turbo up to 3.10-GHz) processor (4.00-MB L3 cache, 15 W), a graphics subsystem with UMA memory, and the Windows 8 Standard operating system (includes replacement thermal material)
778831-601	System board equipped with an Intel Core i7-4510U 2.00-GHz (SC turbo up to 3.10-GHz) processor (4.00-MB L3 cache, 15 W), a graphics subsystem with UMA memory, and the Windows 8 Professional operating system (includes replacement thermal material)
780112-001	Webcam/microphone module for use only on computer models equipped with an AMD processor (includes double-sided adhesive)
780895-001	Fan for use only on computer models equipped with an AMD processor (includes cable)
783215-001	Top cover for use only on computer models equipped with an AMD processor
783989-001	LTE antenna for use only in Japan

---

# 4 Removal and replacement preliminary requirements

## Tools required

You will need the following tools to complete the removal and replacement procedures:

- Flat-bladed screw driver
- Magnetic screw driver
- Phillips PO screw driver

## Service considerations

The following sections include some of the considerations that you must keep in mind during disassembly and assembly procedures.

---

 **NOTE:** As you remove each subassembly from the computer, place the subassembly (and all accompanying screws) away from the work area to prevent damage.

---

## Plastic parts

---

 **CAUTION:** Using excessive force during disassembly and reassembly can damage plastic parts. Use care when handling the plastic parts. Apply pressure only at the points designated in the maintenance instructions.

---

## Cables and connectors

---

**⚠ CAUTION:** When servicing the computer, be sure that cables are placed in their proper locations during the reassembly process. Improper cable placement can damage the computer.

---

Cables must be handled with extreme care to avoid damage. Apply only the tension required to unseat or seat the cables during removal and insertion. Handle cables by the connector whenever possible. In all cases, avoid bending, twisting, or tearing cables. Be sure that cables are routed in such a way that they cannot be caught or snagged by parts being removed or replaced. Handle flex cables with extreme care; these cables tear easily.

## Drive handling

---

**⚠ CAUTION:** Drives are fragile components that must be handled with care. To prevent damage to the computer, damage to a drive, or loss of information, observe these precautions:

Before removing or inserting a hard drive, shut down the computer. If you are unsure whether the computer is off or in Hibernation, turn the computer on, and then shut it down through the operating system.

Before handling a drive, be sure that you are discharged of static electricity. While handling a drive, avoid touching the connector.

Before removing a diskette drive or optical drive, be sure that a diskette or disc is not in the drive and be sure that the optical drive tray is closed.

Handle drives on surfaces covered with at least one inch of shock-proof foam.

Avoid dropping drives from any height onto any surface.

After removing a hard drive, an optical drive, or a diskette drive, place it in a static-proof bag.

Avoid exposing an internal hard drive to products that have magnetic fields, such as monitors or speakers.

Avoid exposing a drive to temperature extremes or liquids.

If a drive must be mailed, place the drive in a bubble pack mailer or other suitable form of protective packaging and label the package "FRAGILE."

---

# Grounding guidelines

## Electrostatic discharge damage

Electronic components are sensitive to electrostatic discharge (ESD). Circuitry design and structure determine the degree of sensitivity. Networks built into many integrated circuits provide some protection, but in many cases, ESD contains enough power to alter device parameters or melt silicon junctions.

A discharge of static electricity from a finger or other conductor can destroy static-sensitive devices or microcircuitry. Even if the spark is neither felt nor heard, damage may have occurred.

An electronic device exposed to ESD may not be affected at all and can work perfectly throughout a normal cycle. Or the device may function normally for a while, then degrade in the internal layers, reducing its life expectancy.

**⚠ CAUTION:** To prevent damage to the computer when you are removing or installing internal components, observe these precautions:

Keep components in their electrostatic-safe containers until you are ready to install them.

Before touching an electronic component, discharge static electricity by using the guidelines described in this section.

Avoid touching pins, leads, and circuitry. Handle electronic components as little as possible.

If you remove a component, place it in an electrostatic-safe container.

The following table shows how humidity affects the electrostatic voltage levels generated by different activities.

**⚠ CAUTION:** A product can be degraded by as little as 700 V.

Typical electrostatic voltage levels			
Event	Relative humidity		
	10%	40%	55%
Walking across carpet	35,000 V	15,000 V	7,500 V
Walking across vinyl floor	12,000 V	5,000 V	3,000 V
Motions of bench worker	6,000 V	800 V	400 V
Removing DIPS from plastic tube	2,000 V	700 V	400 V
Removing DIPS from vinyl tray	11,500 V	4,000 V	2,000 V
Removing DIPS from Styrofoam	14,500 V	5,000 V	3,500 V
Removing bubble pack from PCB	26,500 V	20,000 V	7,000 V
Packing PCBs in foam-lined box	21,000 V	11,000 V	5,000 V

## Packaging and transporting guidelines

Follow these grounding guidelines when packaging and transporting equipment:

- To avoid hand contact, transport products in static-safe tubes, bags, or boxes.
- Protect ESD-sensitive parts and assemblies with conductive or approved containers or packaging.
- Keep ESD-sensitive parts in their containers until the parts arrive at static-free workstations.
- Place items on a grounded surface before removing items from their containers.
- Always be properly grounded when touching a component or assembly.
- Store reusable ESD-sensitive parts from assemblies in protective packaging or nonconductive foam.
- Use transporters and conveyors made of antistatic belts and roller bushings. Be sure that mechanized equipment used for moving materials is wired to ground and that proper materials are selected to avoid static charging. When grounding is not possible, use an ionizer to dissipate electric charges.

## Workstation guidelines

Follow these grounding workstation guidelines:

- Cover the workstation with approved static-shielding material.
- Use a wrist strap connected to a properly grounded work surface and use properly grounded tools and equipment.
- Use conductive field service tools, such as cutters, screw drivers, and vacuums.
- When fixtures must directly contact dissipative surfaces, use fixtures made only of static-safe materials.
- Keep the work area free of nonconductive materials, such as ordinary plastic assembly aids and Styrofoam.
- Handle ESD-sensitive components, parts, and assemblies by the case or PCM laminate. Handle these items only at static-free workstations.
- Avoid contact with pins, leads, or circuitry.
- Turn off power and input signals before inserting or removing connectors or test equipment.

## Equipment guidelines

Grounding equipment must include either a wrist strap or a foot strap at a grounded workstation.

- When seated, wear a wrist strap connected to a grounded system. Wrist straps are flexible straps with a minimum of one megohm  $\pm 10\%$  resistance in the ground cords. To provide proper ground, wear a strap snugly against the skin at all times. On grounded mats with banana-plug connectors, use alligator clips to connect a wrist strap.
- When standing, use foot straps and a grounded floor mat. Foot straps (heel, toe, or boot straps) can be used at standing workstations and are compatible with most types of shoes or boots. On conductive floors or dissipative floor mats, use foot straps on both feet with a minimum of one megohm resistance between the operator and ground. To be effective, the conductive must be worn in contact with the skin.

The following grounding equipment is recommended to prevent electrostatic damage:

- Antistatic tape
- Antistatic smocks, aprons, and sleeve protectors
- Conductive bins and other assembly or soldering aids
- Nonconductive foam
- Conductive computerop workstations with ground cords of one megohm resistance
- Static-dissipative tables or floor mats with hard ties to the ground
- Field service kits
- Static awareness labels
- Material-handling packages
- Nonconductive plastic bags, tubes, or boxes
- Metal tote boxes
- Electrostatic voltage levels and protective materials

The following table lists the shielding protection provided by antistatic bags and floor mats.

<b>Material</b>	<b>Use</b>	<b>Voltage protection level</b>
Antistatic plastics	Bags	1,500 V
Carbon-loaded plastic	Floor mats	7,500 V
Metallized laminate	Floor mats	5,000 V





# 5 Removal and replacement procedures for Customer Self-Repair parts

 **NOTE:** The Customer Self-Repair program is not available in all locations. Installing a part not supported by the Customer Self-Repair program may void your warranty. Check your warranty to determine if Customer Self-Repair is supported in your location.

 **NOTE:** HP continually improves and changes product parts. For complete and current information on supported parts for your computer, go to <http://partsurfer.hp.com>, select your country or region, and then follow the on-screen instructions.

## Component replacement procedures

This chapter provides removal and replacement procedures for Authorized Service Provider only parts.

There are as many as 15 screws that must be removed, replaced, and/or loosened when servicing the computer. Make special note of each screw size and location during removal and replacement.

### Service cover

 **NOTE:** The service cover spare part kit includes rubber feet.

Description	Spare part number
For use only on computer models equipped with an AMD processor	766018-001
For use only on computer models equipped with an Intel processor:	
For use only on computer models equipped with a TouchScreen display assembly	761780-001
For use only on computer models equipped with a non-TouchScreen display assembly with a CCCO mark	730564-001
For use only on computer models equipped with a non-TouchScreen display assembly and with RCTO	745308-001

Before removing the disassembling the computer, follow these steps:

1. Turn off the computer. If you are unsure whether the computer is off or in Hibernation, turn the computer on, and then shut it down through the operating system.
2. Disconnect the power from the computer by unplugging the power cord from the computer.
3. Disconnect all external devices from the computer.

Remove the service cover:

1. Turn the computer upside down, with the rear toward you.
2. Slide the service cover release latch **(1)** to gain access to the service cover security screw.
3. Remove the Phillips PM2.0×4.5 security screw **(2)** (if present).

 **NOTE:** The service cover includes a threaded receptacle for storing the security screw.

4. Slide the service cover release latch a second time **(3)** to release the service cover.
5. Release the service cover **(4)** by sliding it forward.
6. Remove the service cover **(5)**.

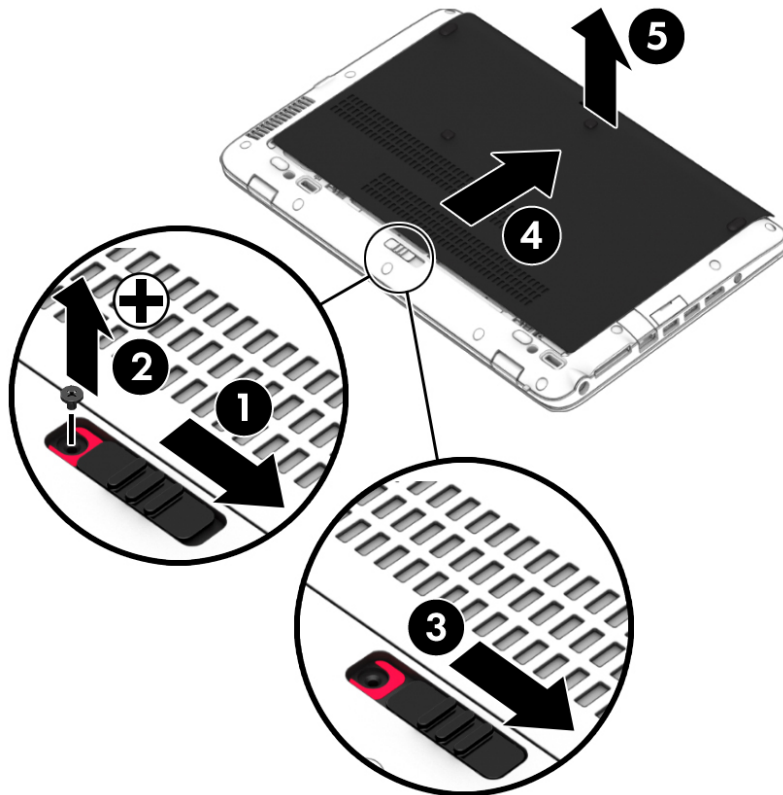

Reverse this procedure to install the service cover.

## Battery

Description	Spare part number
3-cell, 46-WHr, 4.15-AHr, Li-ion battery	717378-001
3-cell, 26-WHr, 2.50-AHr, Li-ion battery	717377-001

Before removing the battery, follow these steps:

1. Turn off the computer. If you are unsure whether the computer is off or in Hibernation, turn the computer on, and then shut it down through the operating system.
2. Disconnect the power from the computer by unplugging the power cord from the computer.
3. Disconnect all external devices from the computer.
4. Remove the service cover (see [Service cover on page 71](#)).

 **WARNING!** To reduce potential safety issues, use only the battery provided with the computer, a replacement battery provided by HP, or a compatible battery purchased from HP.

 **CAUTION:** Removing a battery that is the sole power source for the computer can cause loss of information. To prevent loss of information, save your work or shut down the computer through Windows before removing the battery.

Remove the battery:

1. Slide the battery lock latches **(1)** to unlock the battery.

2. Use the release tab **(2)** to lift the rear edge of the battery **(3)** until the battery rests at an angle.

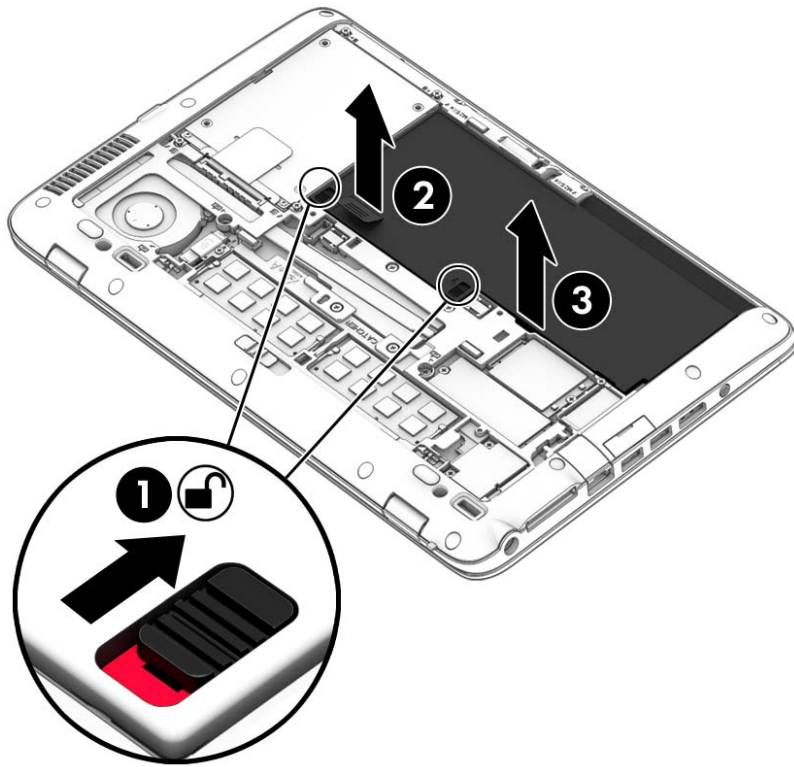

3. Remove the battery.

Reverse this procedure to install the battery.

## Hard drive



**NOTE:** The hard drive spare part kit does not include the hard drive bracket, hard drive connector adapter, or screws. The hard drive bracket, hard drive connector adapter, and screws are included in the Hard Drive Hardware Kit, spare part number 730539-001.

Description	Spare part number
For use on all computer models:	
500-GB, 7200-rpm, SATA, 7.0-mm hard drive	703267-001
500-GB, 7200-rpm, SED, 7.0-mm hard drive	703268-001
500-GB, 5400-rpm, SATA, FIPS, 7.0-mm hard drive	730946-001
320-GB, 7200-rpm, SATA, 7.0-mm hard drive	634862-001
For use only on computer models equipped with an AMD processor:	
1-TB, 5400-rpm, SATA, 7.0-mm hard drive	762990-001
For use only on computer models equipped with an Intel processor:	
500-GB, 5400-rpm, SATA, 7.0-mm hard drive	683802-001
500-GB, 5400-rpm, SATA, locked, 7.0-mm hard drive	763522-001
500-GB, 5400-rpm, SATA, locked, 7.0-mm hard drive	776626-001

Before removing the battery, follow these steps:

1. Turn off the computer. If you are unsure whether the computer is off or in Hibernation, turn the computer on, and then shut it down through the operating system.
2. Disconnect the power from the computer by unplugging the power cord from the computer.
3. Disconnect all external devices from the computer.
4. Remove the service cover (see [Service cover on page 71](#)).
5. Remove the battery (see [Battery on page 73](#)).

Remove the hard drive:

1. Loosen the four Phillips captive screws **(1)** that secure the hard drive to the computer.

2. Use the release tab **(2)** to remove the hard drive.

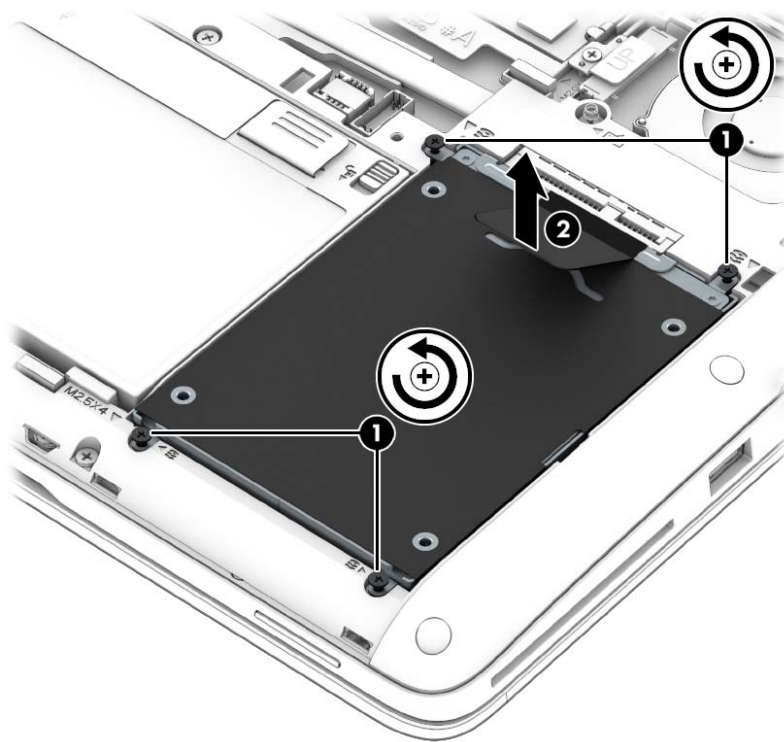

3. If it is necessary to disassemble the hard drive, perform the following steps:
  - a. Position the hard drive with the rear toward you.
  - b. Remove the four Phillips PM2.75×3.5 screws **(1)** that secure the hard drive bracket to the hard drive.
  - c. Remove the hard drive bracket **(2)** from the hard drive.

- d. Remove the hard drive connector adapter **(3)** from the hard drive.

The hard drive bracket, hard drive connector adapter, and screws are available in the Hard Drive Hardware Kit, spare part number 730539-001.

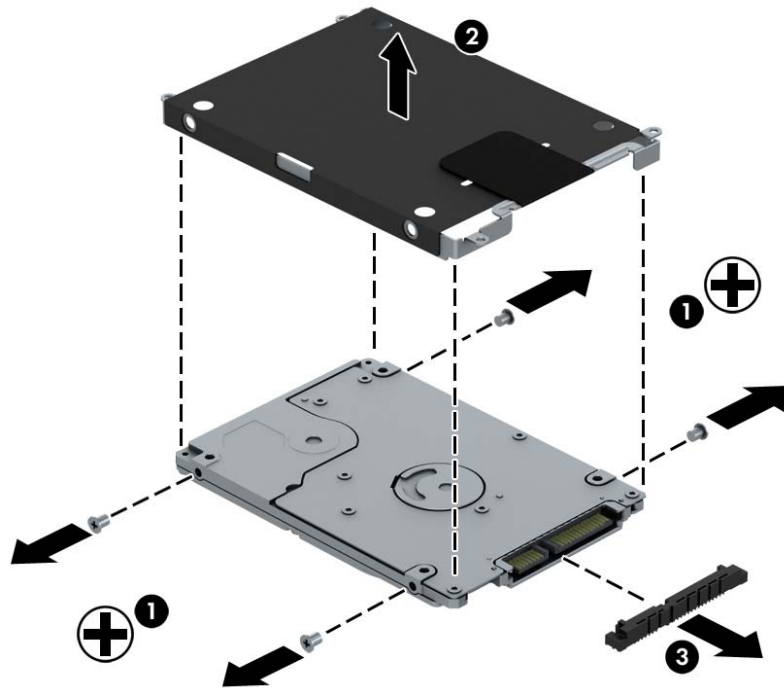

Reverse this procedure to reassemble and install the hard drive.

## WWAN module

Description	Spare part number
For use only on computer models equipped with an AMD processor:	
HP hs3110 HSPA+ Mobile Broadband Module	748599-001
HP It4112 LTE/HSPA+ Mobile Broadband Module	740011-001
HP It4111 LTE/EV-DO/HSPA+ Mobile Broadband Module	748021-001
For use only on computer models equipped with an Intel processor:	
HP hs3110 HSPA+ Mobile Broadband Module	723895-001
HP It4226 LTE/HSPA+4G Module	736675-001
HP It4225 LTE/EV-DO 4G Module	736676-001
HP It4112 LTE/HSPA+ Mobile Broadband Module	704031-001
HP It4111 LTE/EV-DO/HSPA+ Mobile Broadband Module	704030-001

Before removing the WWAN module, follow these steps:

1. Turn off the computer. If you are unsure whether the computer is off or in Hibernation, turn the computer on, and then shut it down through the operating system.
2. Disconnect the power from the computer by unplugging the power cord from the computer.
3. Disconnect all external devices from the computer.
4. Remove the service cover (see [Service cover on page 71](#)).
5. Remove the battery (see [Battery on page 73](#)).

Remove the WWAN module:

1. Disconnect the WWAN antenna cables **(1)** from the terminals on the WWAN module.





**NOTE:** The WWAN antenna cable labeled “5” connects to the WWAN module “Main” terminal labeled “5”. The WWAN antenna cable labeled “6” connects to the WWAN module “Aux/GPS” terminal labeled “6”.

2. Remove the Phillips PM2.0×2.5 screw **(2)** that secures the WWAN module to the system board. (The WWAN module tilts up.)

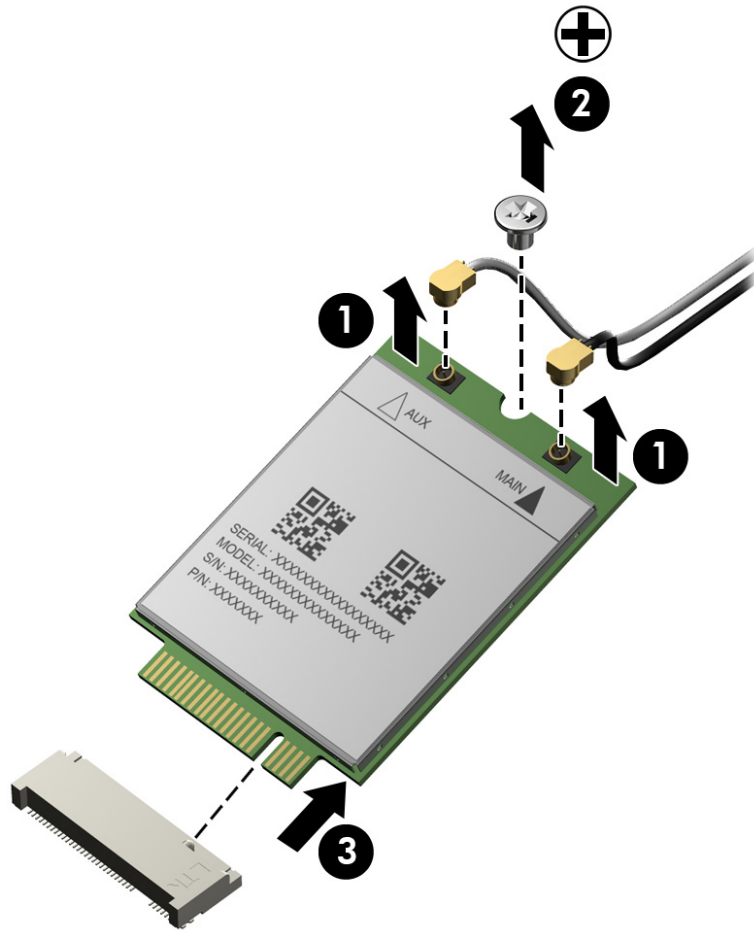

3. Remove the WWAN module **(3)** by pulling the module away from the slot at an angle.



 **NOTE:** If the WWAN antenna cables are not connected to the terminals on the WWAN module, protective sleeves should be installed on the antenna connectors, as shown in the following illustration.

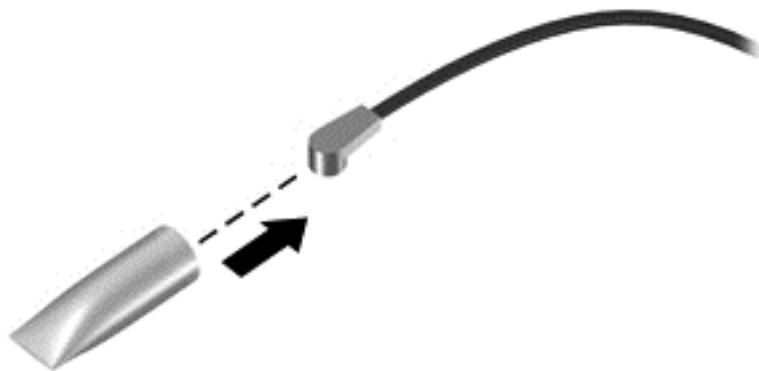

Reverse this procedure to install the WWAN module.

## Solid-state drive

Description	Spare part number
For use only on computer models equipped with an AMD processor:	
256-GB, SATA-3, SED, Opal 2, solid-state drive	765614-001
256-GB, SATA-3, SED, Opal 1, solid-state drive	765613-001
240-GB, SATA-3, solid-state drive	765612-001
180-GB, SATA-3, SED, Opal 1, solid-state drive	765611-001
180-GB, SATA-3, solid-state drive	765610-001
128-GB, SATA-3, solid-state drive	765609-001
For use only on computer models equipped with an Intel processor:	
512-GB, SATA-3, solid-state drive	752103-001
256-GB, SATA-3, SED, Opal 2, solid-state drive	761906-001
256-GB, SATA-3, SATA-3, Opal 2, locked, solid-state drive	777832-001
256-GB, SATA-3, SED solid-state drive	730567-001
240-GB, SATA-3, solid-state drive	730566-001
180-GB, SATA-3, SED, Opal 1, solid-state drive	775247-001
180-GB, SATA-3, solid-state drive	730565-001
128-GB, SATA-3, locked, Opal 2, solid-state drive	764507-001
128-GB, SATA-3, locked, solid-state drive	766679-001
128-GB, SATA-3, solid-state drive	744716-001
120-GB, mSATA-3, SED solid-state drive	730568-001
32-GB, SATA-3, solid-state drive	743008-001

Before removing the solid-state drive, follow these steps:

1. Turn off the computer. If you are unsure whether the computer is off or in Hibernation, turn the computer on, and then shut it down through the operating system.
2. Disconnect the power from the computer by unplugging the power cord from the computer.
3. Disconnect all external devices from the computer.
4. Remove the service cover (see [Service cover on page 71](#)).
5. Remove the battery (see [Battery on page 73](#)).

Remove the solid-state drive:

1. Remove the Phillips PM2.0×2.5 screw **(1)** that secures the solid-state drive to the system board. (The solid-state drive tilts up.)

2. Remove the solid-state drive **(2)** by pulling the drive away from the slot at an angle.

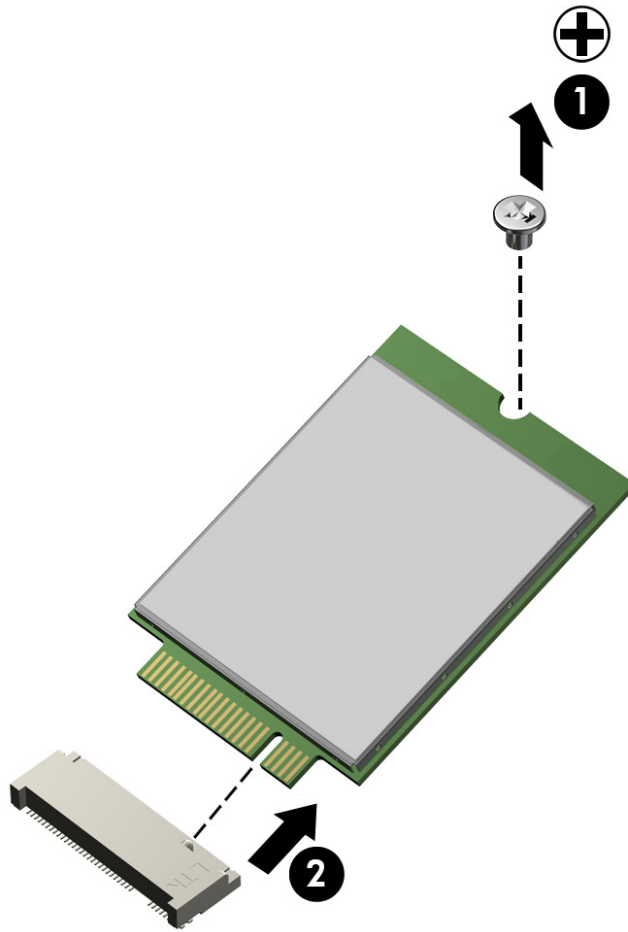

Reverse this procedure to install the solid-state drive.

## WLAN module

Description	Spare part number
For use only on computer models equipped with an AMD processor:	
Atheros AR9485 802.11 b/g/n WiFi Adapter	675794-001
Broadcom BCM943228HMB 802.11 abgn 2x2 Wi-Fi Adapter, Broadcom Bluetooth 4.0 Adapter	730668-001
Broadcom BCM4352 802.11 ac 2x2 Wi-Fi + Bluetooth 4.0 Combo Adapter	724935-001
For use only on computer models equipped with an Intel processor:	
Broadcom BCM943228HMB 802.11 a/b/g/n 2x2 Wi-Fi + Bluetooth 4.0 Combo Adapter	697316-001
Intel Dual Band Wireless-AC 7260 802.11 ac 2x2 WiFi + Bluetooth 4.0 WLAN module	710661-001
Intel Dual Band Wireless-N 7260AN 802.11 a/b/g/n 2x2 Wi-Fi + Bluetooth 4.0 Combo Adapter	717381-001
Intel Dual Band Wireless-N 7260AN 802.11 a/b/g/n 2x2 Wi-Fi + Bluetooth 4.0 Combo Adapter	747832-001
Intel Dual Band Wireless-N 7260NB 802.11 a/b/g/n 2x2 WiFi Adapter	717382-001

Before removing the WLAN module, follow these steps:

1. Turn off the computer. If you are unsure whether the computer is off or in Hibernation, turn the computer on, and then shut it down through the operating system.
2. Disconnect the power from the computer by unplugging the power cord from the computer.
3. Disconnect all external devices from the computer.
4. Remove the service cover (see [Service cover on page 71](#)).
5. Remove the battery (see [Battery on page 73](#)).

Remove the WLAN module:

1. Disconnect the WLAN antenna cables **(1)** from the terminals on the WLAN module.

 **NOTE:** The WLAN antenna cable labeled "1" connects to the WLAN module "Main" terminal labeled "1". The WLAN antenna cable labeled "2" connects to the WLAN module "Aux" terminal labeled "2".

2. Remove the two Phillips PM2.0x2.5 screws **(2)** that secure the WLAN module to the system board. (The WLAN module tilts up.)

3. Remove the WLAN module (3) by pulling the module away from the slot at an angle.

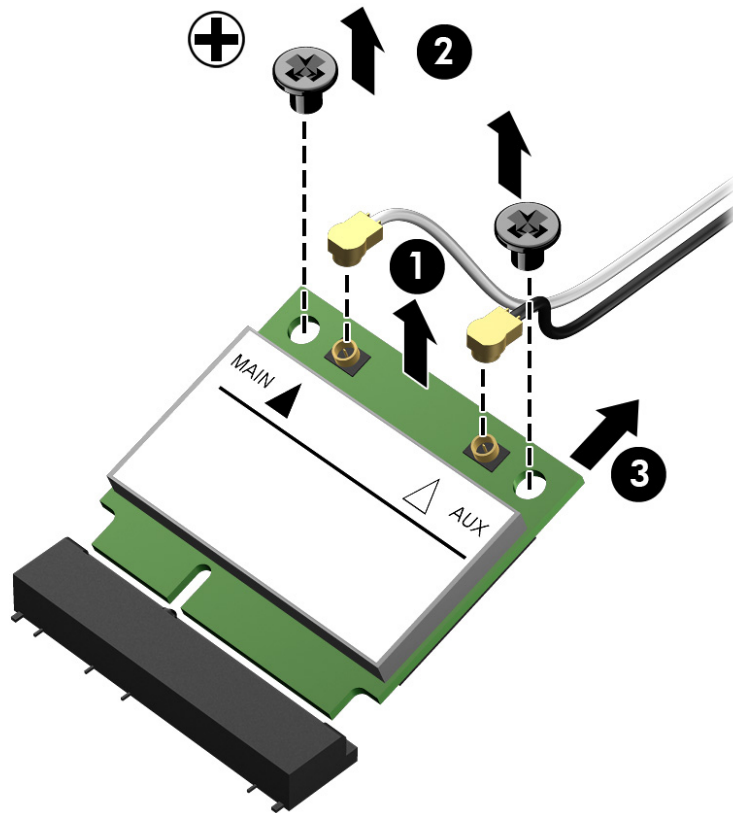

 **NOTE:** If the WLAN antenna cables are not connected to the terminals on the WLAN module, protective sleeves should be installed on the antenna connectors, as shown in the following illustration.

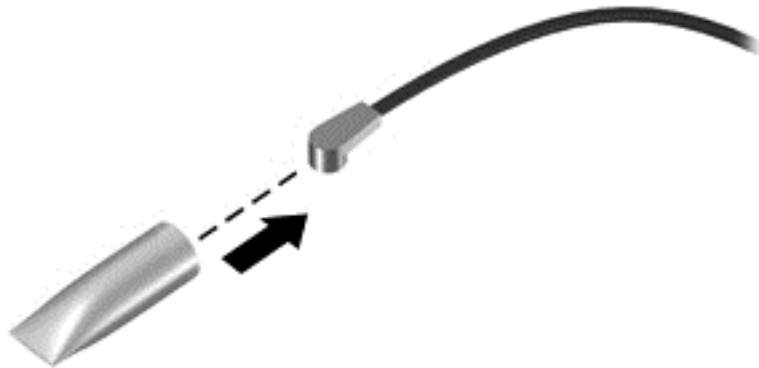

Reverse this procedure to install the WLAN module.

## Memory module

Description	Spare part number
8 GB (PCL3, 12800, 1600-MHz)	693374-001
4 GB (PCL3, 12800, 1600-MHz)	691740-001

Before removing the memory module, follow these steps:

1. Turn off the computer. If you are unsure whether the computer is off or in Hibernation, turn the computer on, and then shut it down through the operating system.
2. Disconnect the power from the computer by unplugging the power cord from the computer.
3. Disconnect all external devices from the computer.
4. Remove the service cover (see [Service cover on page 71](#)).
5. Remove the battery (see [Battery on page 73](#)).

Remove the memory module:

1. Spread the retaining tabs **(1)** on each side of the memory module slot to release the memory module. (The memory module tilts up.)
2. Remove the memory module **(2)** by pulling the module away from the slot at an angle.

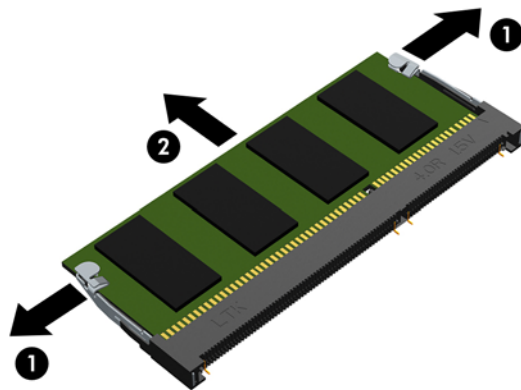

Reverse this procedure to install a memory module.

# Keyboard

<b>For use in country or region</b>	<b>Spare part number</b>	<b>For use in country or region</b>	<b>Spare part number</b>
Keyboard with backlight (includes backlight cable and keyboard cable):			
For use only on computer models equipped with an AMD processor:		For use in the Netherlands	776452-B31
For use in Belgium	776452-A41	For use in Northwest Africa	776452-FP1
For use in Brazil	776452-201	For use in Norway	776452-091
For use in Bulgaria	776452-BA1	For use in Portugal	776452-131
For use in Canada	776452-DB1	For use in Romania	776452-271
For use in the Czech Republic and Slovakia	776452-FL1	For use in the Russia	776452-251
For use in Denmark	776452-081	For use in Saudi Arabia	776452-171
For use in France	776452-051	For use in Slovenia	776452-BA1
For use in Germany	776452-041	For use in South Korea	776452-AD1
For use in Greece	776452-151	For use in Spain	776452-071
For use in Hungary	776452-211	For use in Sweden and Finland	776452-B71
For use in Iceland	776452-DD1	For use in Switzerland	776452-BG1
For use in India	776452-D61	For use in Taiwan	776452-AB1
For use in Israel	776452-BB1	For use in Thailand	776452-281
For use in Italy	776452-061	For use in Turkey	776452-141
For use in Japan	776452-291	For use in the United Kingdom	776452-031
For use in Latin America	776452-161	For use in the United States	776452-001
Keyboard with backlight (includes backlight cable and keyboard cable):			
For use only on computer models equipped with an Intel processor:		For use in the Netherlands	730541-B31
For use in Belgium	730541-A41	For use in Northwest Africa	730541-FP1
For use in Brazil	730541-201	For use in Norway	730541-091
For use in Bulgaria	730541-261	For use in Portugal	730541-131
For use in Canada	730541-DB1	For use in Romania	730541-271
For use in the Czech Republic and Slovakia	730541-FL1	For use in Russia	730541-251
For use in Denmark	730541-081	For use in Saudi Arabia	730541-171
For use in France	730541-051	For use in Slovenia	730541-BA1

<b>For use in country or region</b>	<b>Spare part number</b>	<b>For use in country or region</b>	<b>Spare part number</b>
For use in Germany	730541-041	For use in South Korea	730541-AD1
For use in Greece	730541-151	For use in Spain	730541-071
For use in Hungary	730541-211	For use in Sweden and Finland	730541-B71
For use in Iceland	730541-DD1	For use in Switzerland	730541-BG1
For use in India	730541-D61	For use in Taiwan	730541-AB1
For use in Israel	730541-BB1	For use in Thailand	730541-281
For use in Italy	730541-061	For use in Turkey	730541-141
For use in Japan	730541-291	For use in the United Kingdom and Singapore	730541-031
For use in Latin America	730541-161	For use in the United States	730541-001
Keyboard without backlight (includes keyboard cable):			
For use only on computer models equipped with an AMD processor:		For use in the Netherlands	776451-B31
For use in Belgium	776451-A41	For use in Northwest Africa	776451-FP1
For use in Brazil	776451-201	For use in Norway	776451-091
For use in Bulgaria	776451-261	For use in Portugal	776451-131
For use in Canada	776451-DB1	For use in Romania	776451-271
For use in the Czech Republic and Slovakia	776451-FL1	For use in the Russia	776451-251
For use in Denmark	776451-081	For use in Saudi Arabia	776451-171
For use in France	776451-051	For use in Slovenia	776451-BA1
For use in Germany	776451-041	For use in South Korea	776451-AD1
For use in Greece	776451-151	For use in Spain	776451-071
For use in Hungary	776451-211	For use in Sweden and Finland	776451-B71
For use in Iceland	776451-DD1	For use in Switzerland	776451-BG1
For use in India	776451-D61	For use in Taiwan	776451-AB1
For use in Israel	776451-BB1	For use in Thailand	776451-281
For use in Italy	776451-061	For use in Turkey	776451-141
For use in Japan	776451-291	For use in the United Kingdom	776451-031
For use in Latin America	776451-161	For use in the United States	776451-001
Keyboard without backlight (includes keyboard cable):			



<b>For use in country or region</b>	<b>Spare part number</b>	<b>For use in country or region</b>	<b>Spare part number</b>
For use only on computer models equipped with an Intel processor:		For use in the Netherlands	730540-B31
For use in Belgium	730540-A41	For use in Northwest Africa	730540-FP1
For use in Brazil	730540-201	For use in Norway	730540-091
For use in Bulgaria	730540-261	For use in Portugal	730540-131
For use in Canada	730540-DB1	For use in Romania	730540-271
For use in the Czech Republic and Slovakia	730540-FL1	For use in Russia	730540-251
For use in Denmark	730540-081	For use in Saudi Arabia	730540-171
For use in France	730540-051	For use in Slovenia	730540-BA1
For use in Germany	730540-041	For use in South Korea	730540-AD1
For use in Greece	730540-151	For use in Spain	730540-071
For use in Hungary	730540-211	For use in Sweden and Finland	730540-B71
For use in Iceland	730540-DD1	For use in Switzerland	730540-BG1
For use in India	730540-D61	For use in Taiwan	730540-AB1
For use in Israel	730540-BB1	For use in Thailand	730540-281
For use in Italy	730540-061	For use in Turkey	730540-141
For use in Japan	730540-291	For use in the United Kingdom and Singapore	730540-031
For use in Latin America	730540-161	For use in the United States	730540-001

Before removing the keyboard, follow these steps:

- 1.** Turn off the computer. If you are unsure whether the computer is off or in Hibernation, turn the computer on, and then shut it down through the operating system.
- 2.** Disconnect the power from the computer by unplugging the power cord from the computer.
- 3.** Disconnect all external devices from the computer.
- 4.** Remove the service cover (see [Service cover on page 71](#)).
- 5.** Remove the battery (see [Battery on page 73](#)).

Remove the keyboard:

1. Loosen the two captive screws that secure the keyboard to the computer.

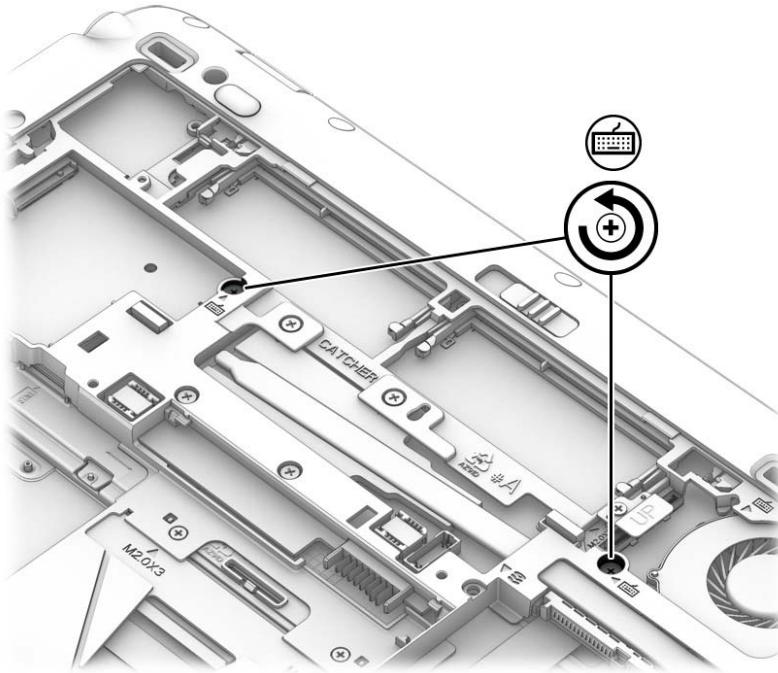

2. Partially open the computer.
3. Rest and secure the computer on its left side.

4. Insert a thin, plastic tool into the keyboard release hole next to the fan, and then press on the back of the keyboard until the keyboard disengages from the computer.

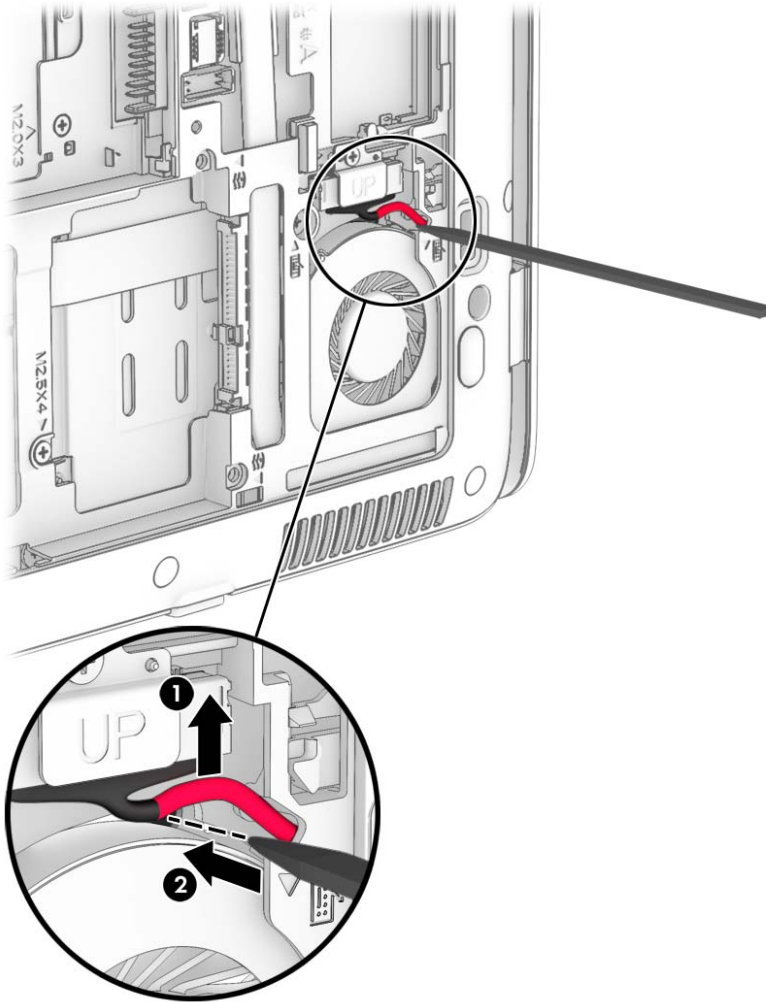

5. Open the computer as far as it will open.
6. Lift the rear edge of the keyboard **(1)** until it rests at an angle.
7. Slide the keyboard **(2)** toward the display until the tabs on the front edge of the keyboard disengage from the top cover.

8. Swing the rear edge of the keyboard **(3)** up and forward until it rests upside down on the palm rest.

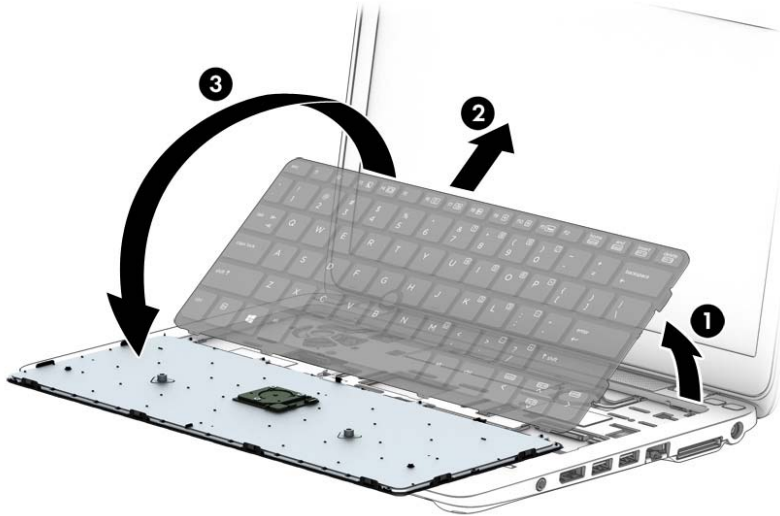

---

 **NOTE:** Step 9 applies only to computer models equipped with a keyboard with backlight.

---

9. Release the zero insertion force (ZIF) connector **(1)** to which the backlight cable is attached, and then disconnect the backlight cable **(2)** from the system board.
10. Release the ZIF connector **(3)** to which the keyboard cable is attached, and then disconnect the keyboard cable **(4)** from the system board.
11. Release the ZIF connector **(5)** to which the pointing stick cable is attached, and then disconnect the pointing stick cable **(6)** from the system board.

12. Remove the keyboard (7).

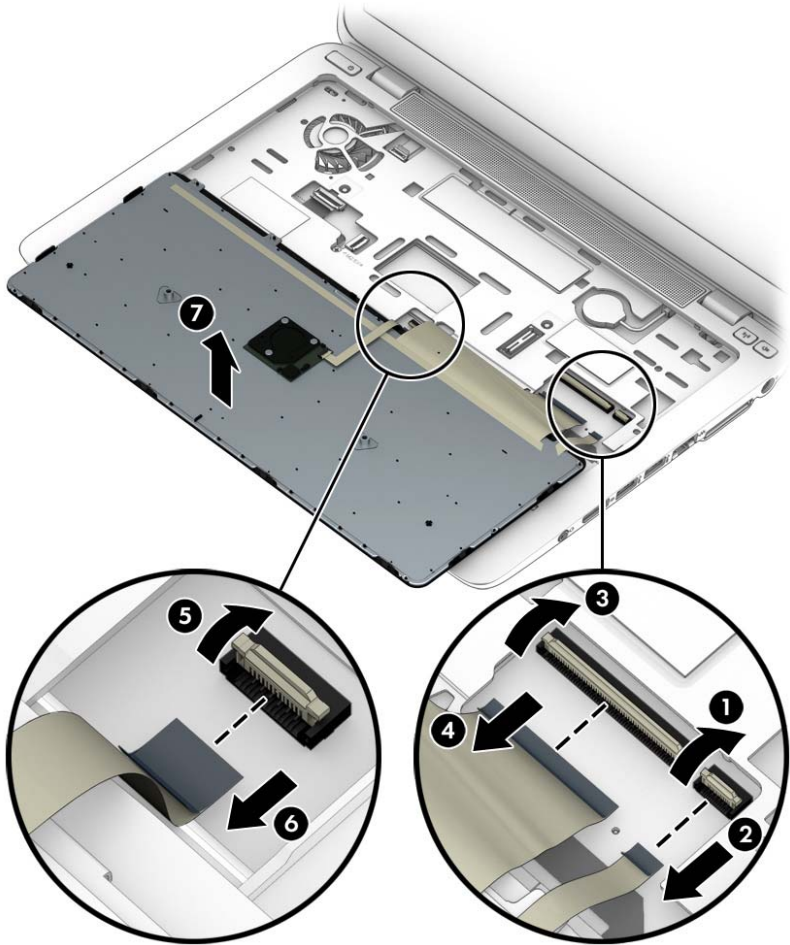

Reverse this procedure to install the keyboard.



---

# 6 Removal and replacement procedures for Authorized Service Provider parts

 **NOTE:** Components described in this chapter should only be accessed by an authorized service provider. Accessing these parts can damage the computer or void the warranty.

 **NOTE:** HP continually improves and changes product parts. For complete and current information on supported parts for your computer, go to <http://partsurfer.hp.com>, select your country or region, and then follow the on-screen instructions.

---

## Component replacement procedures

This chapter provides removal and replacement procedures for Authorized Service Provider only parts.

There are as many as 54 screws that must be removed, replaced, and/or loosened when servicing the computer. Make special note of each screw size and location during removal and replacement.

### RTC battery

Description	Spare part number
RTC battery (includes cable and double-sided adhesive)	702853-001

Before removing the RTC battery, follow these steps:

1. Turn off the computer. If you are unsure whether the computer is off or in Hibernation, turn the computer on, and then shut it down through the operating system.
2. Disconnect the power from the computer by unplugging the power cord from the computer.
3. Disconnect all external devices from the computer.
4. Remove the service cover (see [Service cover on page 71](#)).
5. Remove the battery (see [Battery on page 73](#)).
6. Remove the keyboard (see [Keyboard on page 85](#)).

Remove the RTC battery:

1. Disconnect the RTC battery cable **(1)** from the system board.
2. Detach the RTC battery **(2)** from the top cover. (The RTC battery is attached to the top cover with double-sided adhesive.)

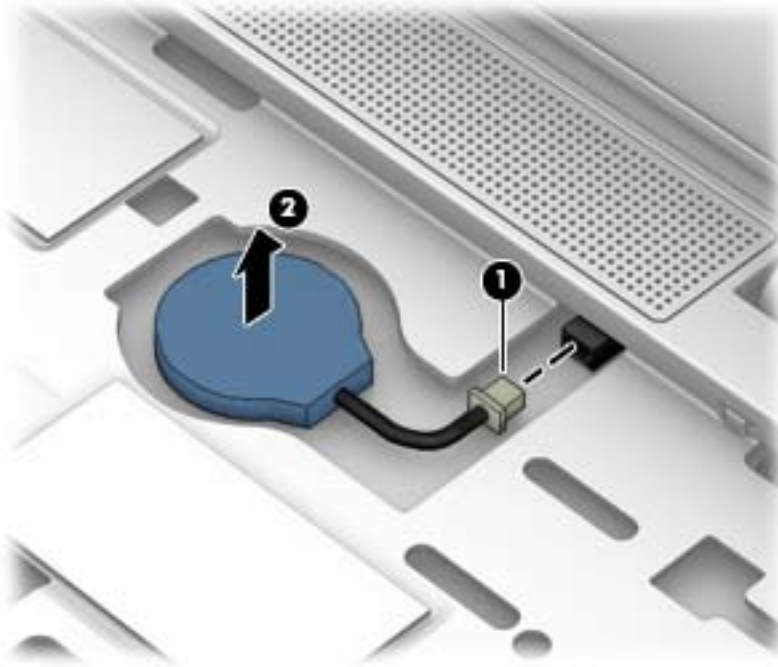

3. Remove the RTC battery and cable.

Reverse this procedure to install the RTC battery.

## Top cover

Description	Spare part number
For use only on computer models equipped with an AMD processor	783215-001
For use only on computer models equipped with an Intel processor	730548-001

Before removing the top cover, follow these steps:

1. Turn off the computer. If you are unsure whether the computer is off or in Hibernation, turn the computer on, and then shut it down through the operating system.
2. Disconnect the power from the computer by unplugging the power cord from the computer.



3. Disconnect all external devices from the computer.
4. Remove the service cover (see [Service cover on page 71](#)), and then remove the following components:
  - a. Battery (see [Battery on page 73](#))
  - b. Hard drive (see [Hard drive on page 75](#))
  - c. Keyboard (see [Keyboard on page 85](#))

 **NOTE:** When replacing the top cover, be sure that the following components are removed from the defective top cover and installed on the replacement top cover:

Remove the top cover:

1. Close the computer.
2. Turn the computer upside down with the front toward you.
3. Remove the Phillips PM2.0×3.25 screw **(1)** that secures the display panel cable bracket and display panel cable to the system board.
4. Remove the display panel cable bracket **(2)**.
5. Disconnect the display panel cable **(3)** from the system board.

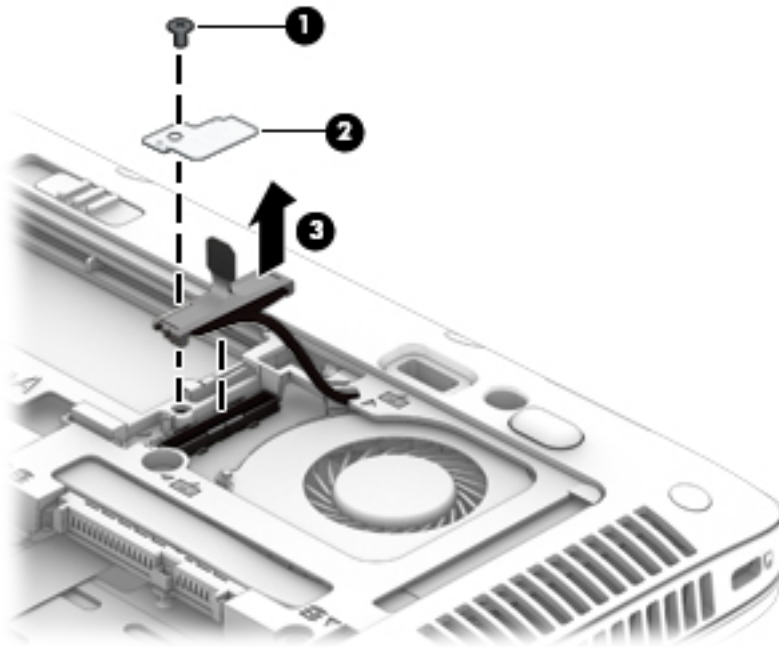

6. Remove the following rubber screw covers:
  - (1)** This screw cover has a "1" marking on the inside of the cover
  - (2)** These screw covers have a "2" marking on the inside of the cover
  - (3)** These screw covers have a "3" marking on the inside of the cover

7. Remove the card reader bezel **(4)** from the card reader slot.

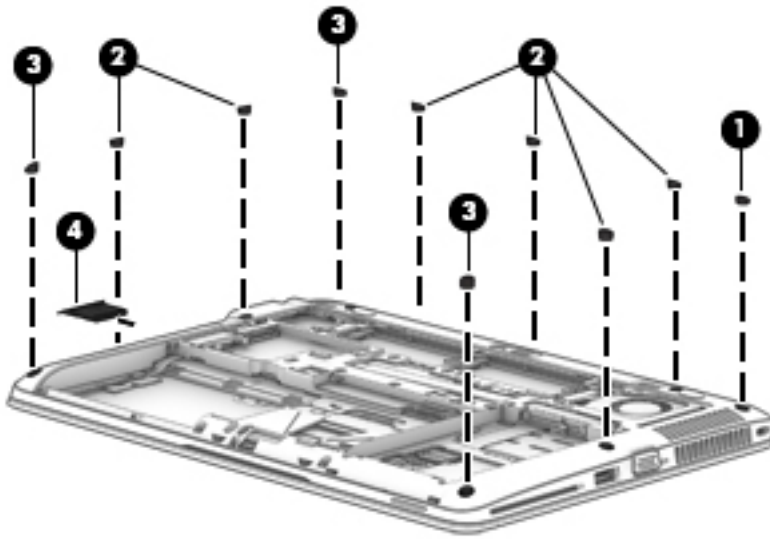

8. Remove the ten Torx T8M2.5x6.5 screws **(1)** that secure the top cover to the base enclosure.

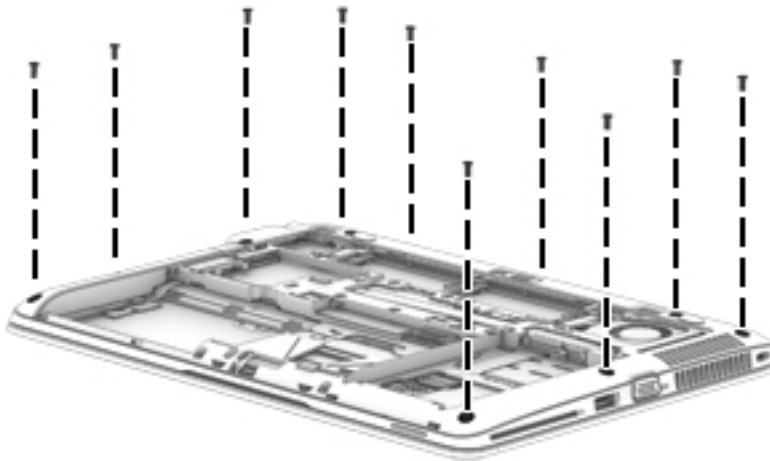

9. Remove the following screws that secure the top cover to the base enclosure:

- (1) One Phillips PM2.0×6.5 screw
- (2) Three Phillips PM2.5×4.5 screws
- (3) Two Phillips PM2.0×3.0 screws

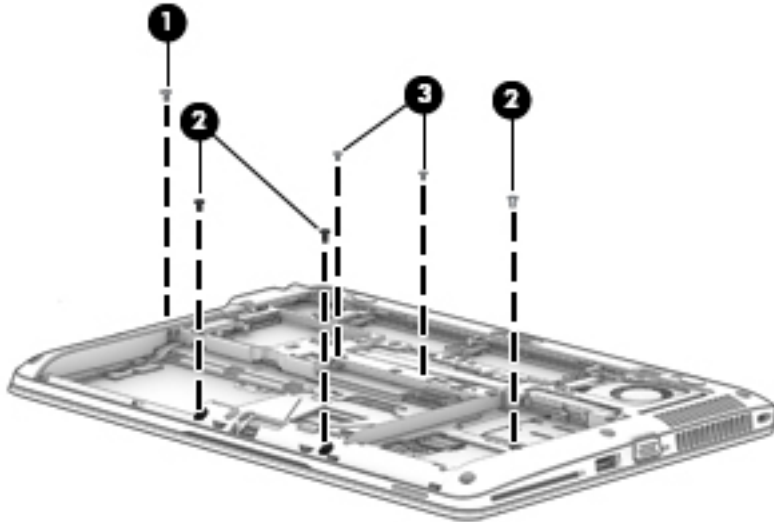

10. Remove the two Phillips PM2.5×4.5 screws (1) that secure the top cover to the base enclosure.

11. Remove the top cover (2).

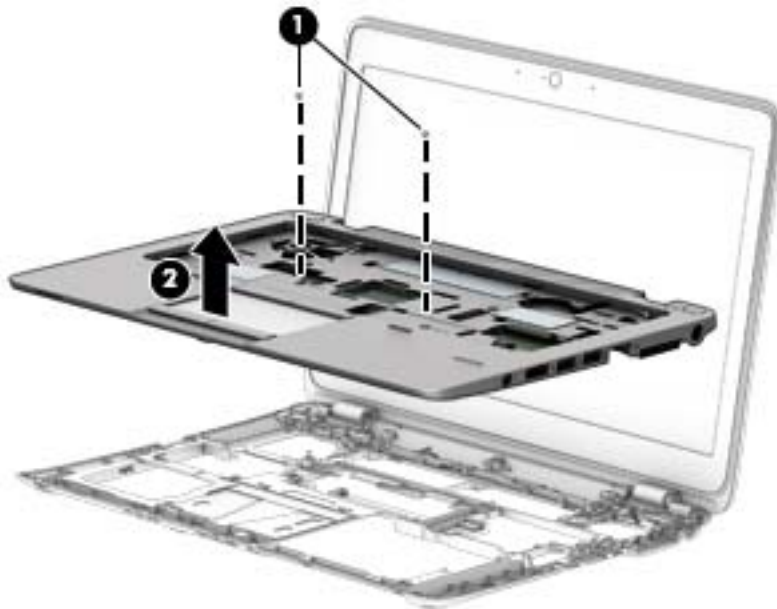

Reverse this procedure to install the top cover.

## Display assembly



**NOTE:** The TouchScreen display assembly is spared as a whole unit replacement. The non-TouchScreen display assembly is spared at the subcomponent level only. For more display assembly spare part information, see the individual removal subsections.

Description	Spare part number
12.5-in, AntiGlare, FHD, LED, UWVA, TouchScreen display assembly for use only on computer models equipped with an AMD processor	765606-001
12.5-in, AntiGlare, HD, LED, UWVA, TouchScreen display assembly for use only on computer models equipped with an Intel processor	761781-001

Before removing the display assembly, follow these steps:

1. Turn off the computer. If you are unsure whether the computer is off or in Hibernation, turn the computer on, and then shut it down through the operating system.
2. Disconnect the power from the computer by unplugging the power cord from the computer.
3. Disconnect all external devices from the computer.
4. Remove the service cover (see [Service cover on page 71](#)), and then remove the following components:
  - a. Battery (see [Battery on page 73](#))
  - b. Hard drive (see [Hard drive on page 75](#))
  - c. Keyboard (see [Keyboard on page 85](#))
  - d. Top cover (see [Top cover on page 94](#))

Remove the display assembly:

1. Release the display panel cable from the routing clips **(1)** and channel built into the base enclosure.

2. Release the wireless antenna cables from the routing clips **(2)** and channel built into the base enclosure.

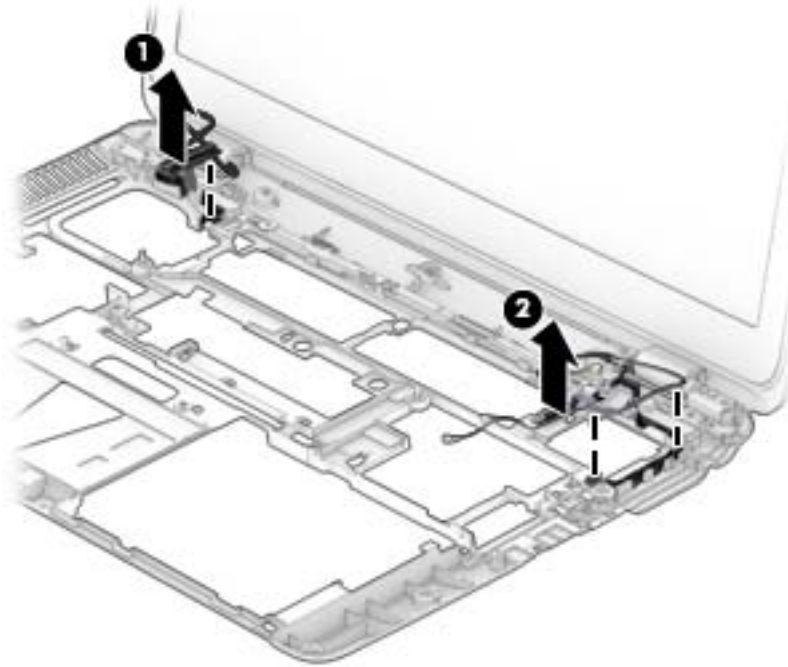

3. Remove the four Phillips PM2.5×4.5 screws **(1)** that secure the display assembly to the base enclosure.

4. Remove the display assembly **(2)**.



5. If it is necessary to replace the display bezel or any of the display assembly subcomponents:

- a. Flex the inside edges of the top edge **(1)**, the left and right sides **(2)**, and the bottom edge **(3)** of the display bezel until the bezel disengages from the display enclosure.
- b. Remove the display bezel **(4)**.

The display bezel is available using the following spare part numbers:

- 775896-001—For use only on computer models equipped with an AMD processor and an AntiGlare, FHD, LED, UWVA display panel
- 766012-001—For use only on computer models equipped with an AMD processor and an AntiGlare, HD, LED, SVA display panel
- 730544-001—For use only on computer models equipped with an Intel processor and an AntiGlare, HD, LED, SVA display panel

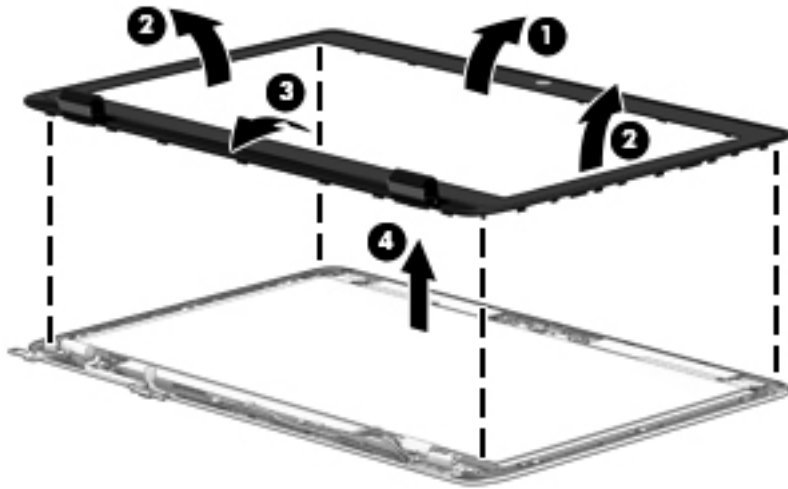

6. If it is necessary to replace the display panel:

- a. Remove the six Phillips PM2.0x3.25 screws **(1)** that secure the display panel to the display enclosure.

**CAUTION:** Before turning the display panel upside down, make sure the work surface is clear of tools, screws, and any other foreign objects. Failure to follow this caution can result in damage to the display panel.

- b. Lift the top edge of the display panel **(2)** and swing it up and forward until it rests upside down in front of the display enclosure.

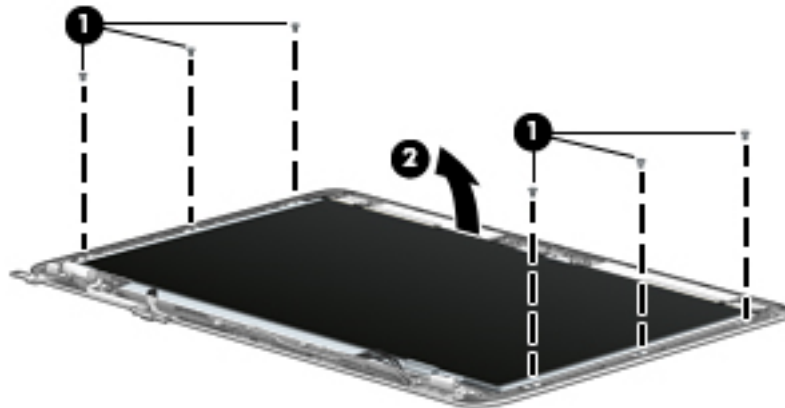

- c. Release the adhesive strip **(1)** that secures the display panel cable connector to the display panel.

- d. Disconnect the display panel cable **(2)** from the display panel.

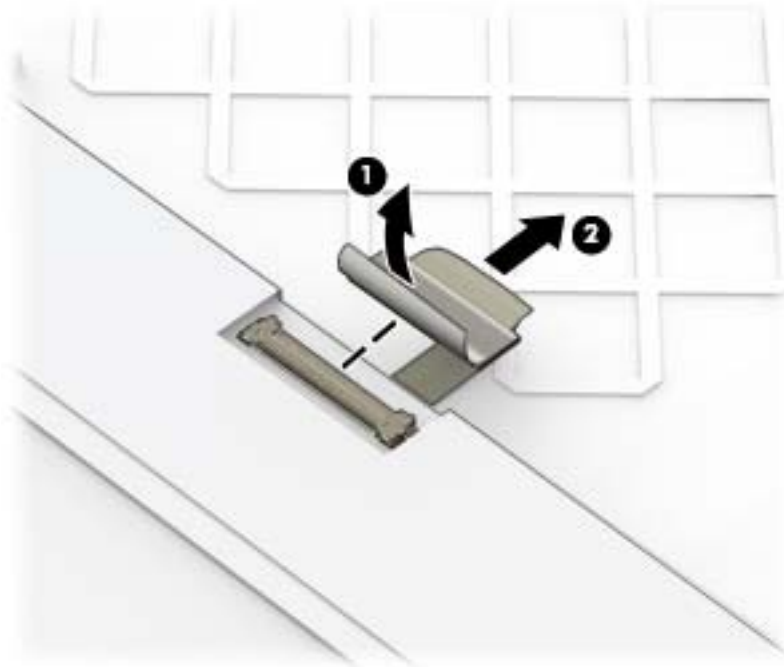

- e. Remove the display panel.

The display panel is available using the following spare part numbers:

- 776930-001–12.5-in, AG, FHD, LED, UWVA display panel for use only on computer models equipped with an AMD processor
  - 765607-001–12.5-in, AG, HD, LED, SVA display panel for use only on computer models equipped with an AMD processor
  - 730536-001–12.5-in, AG, HD, LED, UWVA display panel for use only on computer models equipped with an Intel processor
  - 730535-001–12.5-in, AG, HD, LED, SVA display panel for use only on computer models equipped with an Intel processor
7. If it is necessary to replace the webcam/microphone module or the microphone module:
- a. Detach the webcam/microphone module **(1)** from the display enclosure. (The webcam/microphone module is attached to the display enclosure with double-sided adhesive.)
  - b. Disconnect the webcam/microphone module cable **(2)** from the webcam/microphone module.



- c. Remove the webcam/microphone module **(3)**.

The webcam/microphone module is available using spare part numbers 780112-001 (for use only on computer models equipped with an AMD processor) and 730542-001 (for use only on computer models equipped with an Intel processor). The microphone module is available using spare part number 730795-001.

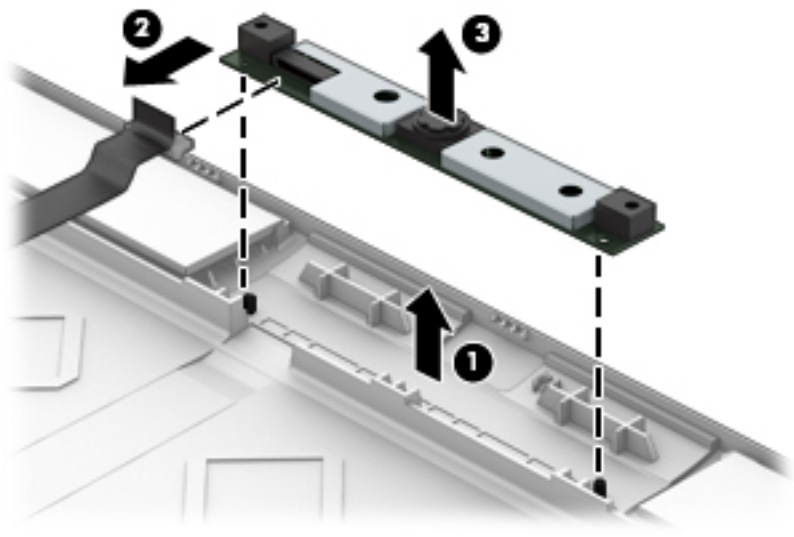

- 8. If it is necessary to replace the display panel cable:

- a. Detach the display panel cable **(1)** from the display enclosure. (The display panel cable is attached to the display enclosure with double-sided adhesive.)
- b. Release the display panel cable from the clip **(2)** built into the display enclosure.
- c. Remove the display panel cable **(3)**.

The display panel cable is included in the Display Cable Kit, spare part number 730537-001, and includes the webcam/microphone module cable.

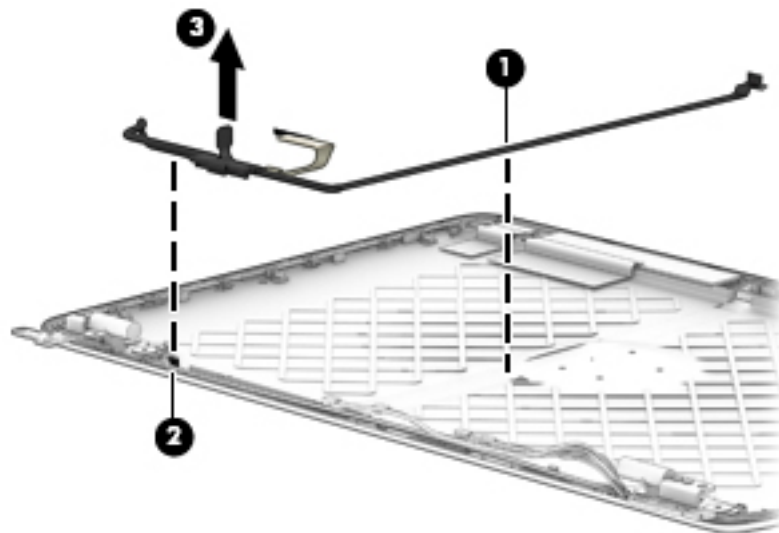

9. If it is necessary to replace the display hinges:
  - a. Release the grounding tape **(1)** that secures the display hinges to the display enclosure.
  - b. Remove the six Phillips PM2.0×3.0 broad head screws **(2)** that secure the display hinges to the display enclosure.
  - c. Remove the display hinges **(3)**.

The display hinges are included in the Display Hinge Kits, spare part numbers 775895-001 (for use only on computer models equipped with an AMD processor) and 730543-001 (for use only on computer models equipped with an Intel processor).

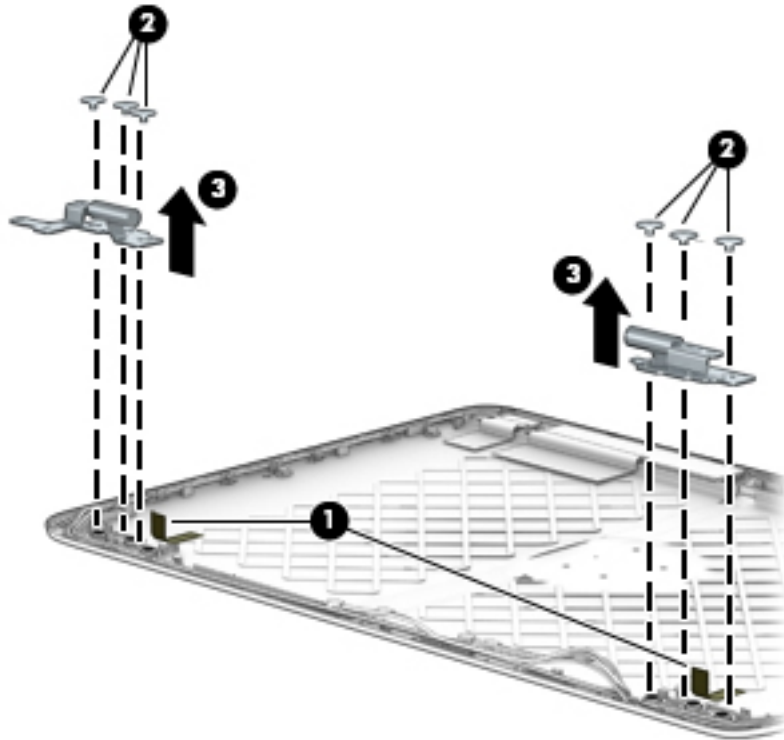

10. If it is necessary to replace the WLAN antenna cables and transceivers:
  - a. Detach the WLAN antenna transceivers **(1)** from the display enclosure. (The WLAN antenna transceivers are attached to the display enclosure with double-sided adhesive.)
  - b. Release the WLAN antenna cables from the clips **(2)** built into the left and right sides of the display enclosure.

- c. Remove the WLAN antenna cables and transceivers **(3)**.

The WLAN antenna cables and transceivers are included in the Antenna Kits, spare part numbers 775894-001 (for use only on computer models equipped with an AMD processor) and 730560-001 (for use only on computer models equipped with an Intel processor).

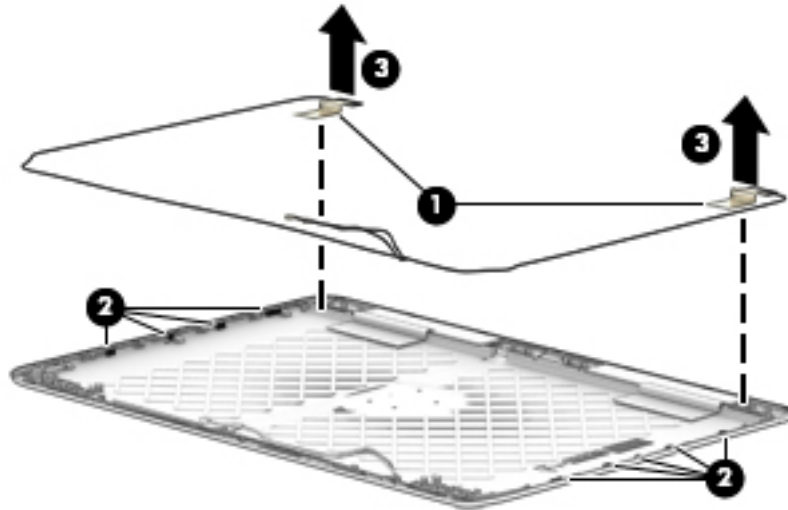

- 11. If it is necessary to replace the WWAN antenna cables and transceivers:

- a. Detach the WWAN antenna transceivers **(1)** from the display enclosure. (The WWAN antenna transceivers are attached to the display enclosure with double-sided adhesive.)
- b. Release the WWAN antenna cables from the clips **(2)** built into the left and right sides of the display enclosure.
- c. Remove the WWAN antenna cables and transceivers **(3)**.

The WWAN antenna cables and transceivers are included in the Antenna Kits, spare part numbers 775894-001 (for use only on computer models equipped with an AMD processor) and 730560-001 (for use only on computer models equipped with an Intel processor).

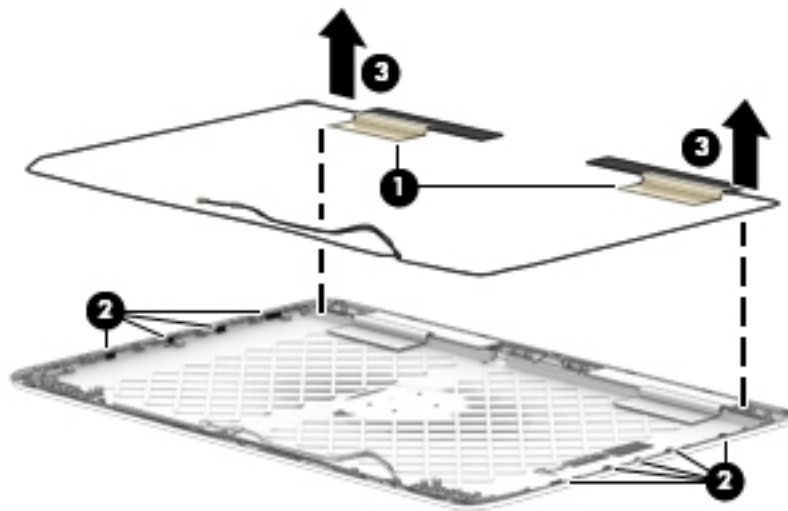

Reverse this procedure to reassemble install the display assembly.

## TouchPad

Description	Spare part number
TouchPad (includes cable)	730549-001

Before removing the TouchPad, follow these steps:

1. Turn off the computer. If you are unsure whether the computer is off or in Hibernation, turn the computer on, and then shut it down through the operating system.
2. Disconnect the power from the computer by unplugging the power cord from the computer.
3. Disconnect all external devices from the computer.
4. Remove the service cover (see [Service cover on page 71](#)), and then remove the following components:
  - a. Battery (see [Battery on page 73](#))
  - b. Hard drive (see [Hard drive on page 75](#))
  - c. Keyboard (see [Keyboard on page 85](#))
  - d. Top cover (see [Top cover on page 94](#))

Remove the TouchPad:

1. Turn the top cover upside down with the front toward you.
2. Release the ZIF connector **(1)** to which the TouchPad cable is attached, and then disconnect the TouchPad cable from the card reader board.
3. Remove the two Phillips PM2.0×3.25 screws **(2)** that secure the TouchPad to the top cover.

4. Remove the TouchPad and cable (3).

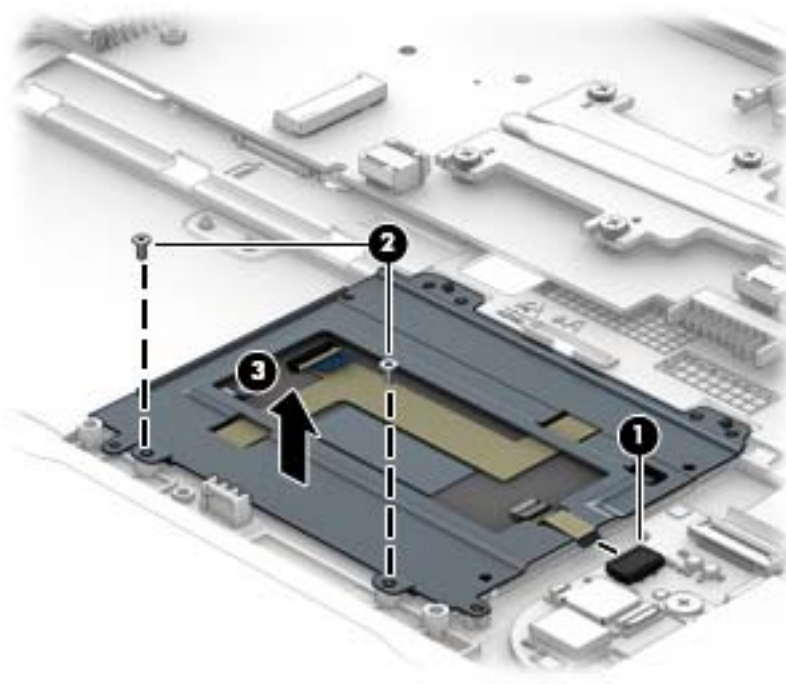

Reverse this procedure to install the TouchPad.

## Card reader board

Description	Spare part number
Card reader board (includes cable)	730563-001

Before removing the card reader board, follow these steps:

1. Turn off the computer. If you are unsure whether the computer is off or in Hibernation, turn the computer on, and then shut it down through the operating system.
2. Disconnect the power from the computer by unplugging the power cord from the computer.
3. Disconnect all external devices from the computer.
4. Remove the service cover (see [Service cover on page 71](#)), and then remove the following components:
  - a. Battery (see [Battery on page 73](#))
  - b. Hard drive (see [Hard drive on page 75](#))
  - c. Keyboard (see [Keyboard on page 85](#))
  - d. Top cover (see [Top cover on page 94](#))

Remove the card reader board:

1. Turn the top cover upside down with the front toward you.
2. Release the ZIF connector **(1)** to which the card reader board cable is attached, and then disconnect the card reader board cable **(2)** from the system board.

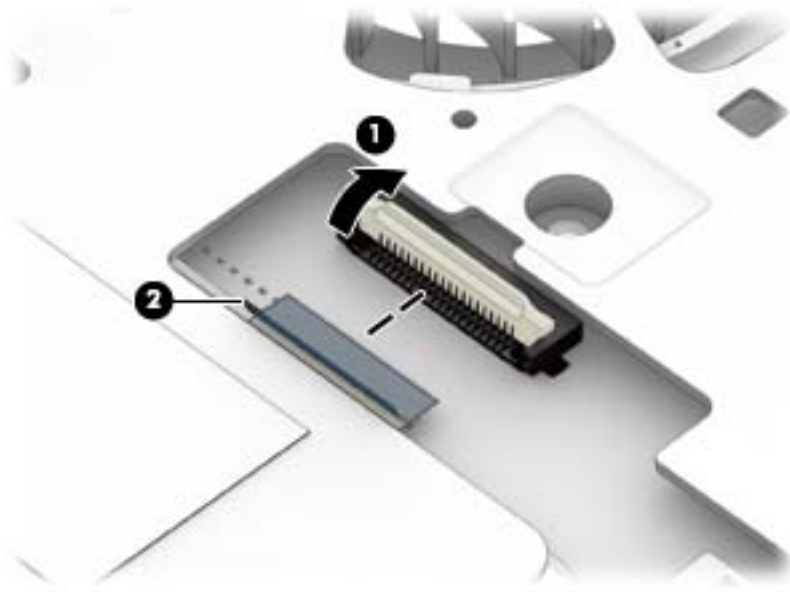

3. Turn the top cover upside down with the front toward you.
4. Release the ZIF connector **(1)** to which the TouchPad cable is attached, and then disconnect the TouchPad cable from the card reader board.
5. Release the card reader board cable **(2)** through the opening in the top cover.
6. Remove the three Phillips PM2.0×2.0 broad head screws **(3)** that secure the card reader board to the top cover.

7. Remove the card reader board and cable (4).

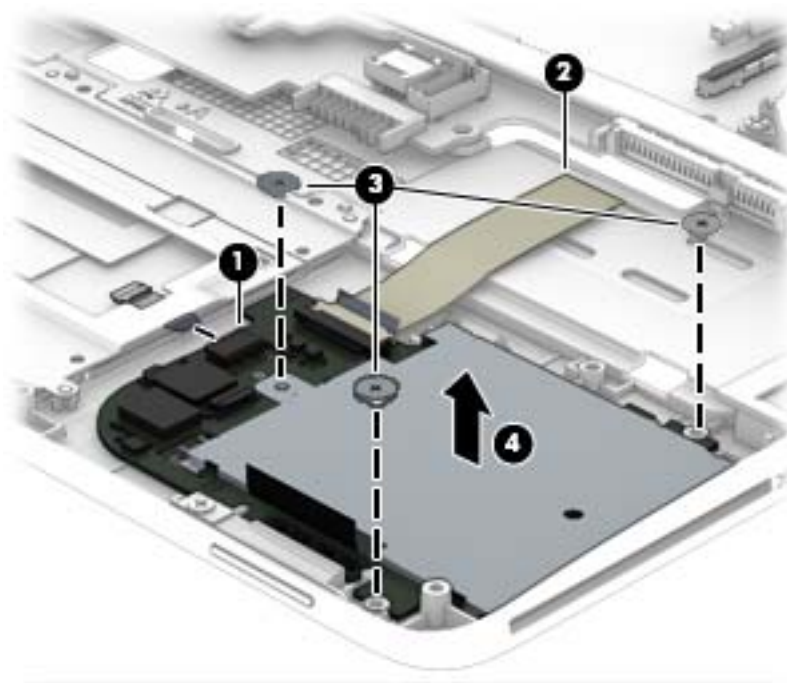

8. Remove the card reader board and cable.  
Reverse this procedure to install the card reader board.



## Heat sink



**NOTE:** The heat sink spare part kit includes replacement thermal material.

Description	Spare part number
For use only on computer models equipped with an AMD processor	765605-001
For use only on computer models equipped with an Intel processor	730556-001

Before removing the heat sink, follow these steps:

1. Turn off the computer. If you are unsure whether the computer is off or in Hibernation, turn the computer on, and then shut it down through the operating system.
2. Disconnect the power from the computer by unplugging the power cord from the computer.
3. Disconnect all external devices from the computer.
4. Remove the service cover (see [Service cover on page 71](#)), and then remove the following components:
  - a. Battery (see [Battery on page 73](#))
  - b. Hard drive (see [Hard drive on page 75](#))
  - c. Keyboard (see [Keyboard on page 85](#))
  - d. Top cover (see [Top cover on page 94](#))

Remove the heat sink:

1. Turn the top cover upside down with the front toward you.
2. Detach the heat sink shroud **(1)** from the fan. (The heat sink shroud is attached to the fan with double-sided adhesive.)
3. Following the 1 through 4 sequence stamped into the heat sink, loosen the four Phillips captive screws **(2)** that secure the heat sink to the system board.

4. Remove the heat sink **(3)**.

 **NOTE:** Due to the adhesive quality of the thermal material located between the heat sink and the system board components, it may be necessary to move the heat sink from side to side to detach it.

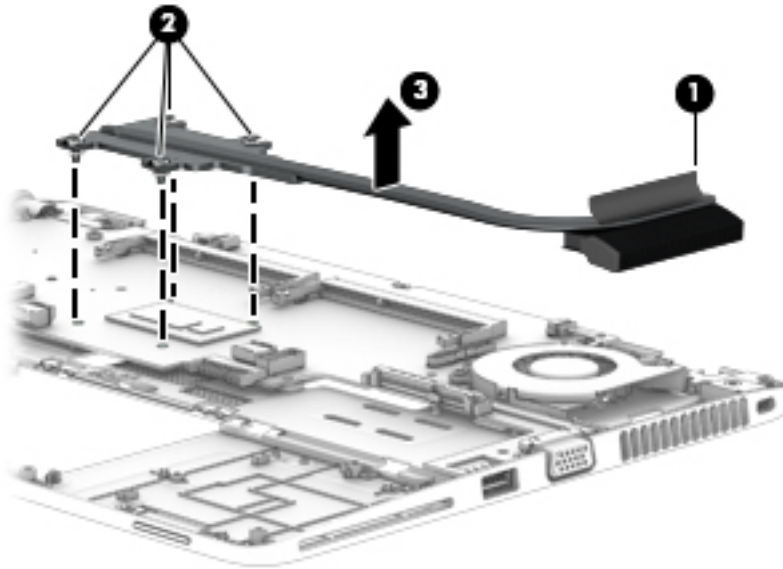

 **NOTE:** The thermal material must be thoroughly cleaned from the surfaces of the heat sink and the system board components each time the heat sink is removed. Replacement thermal material is included with the heat sink and system board spare part kits. Thermal paste is used on the processor **(1)** and the heat sink section **(2)** that services it.

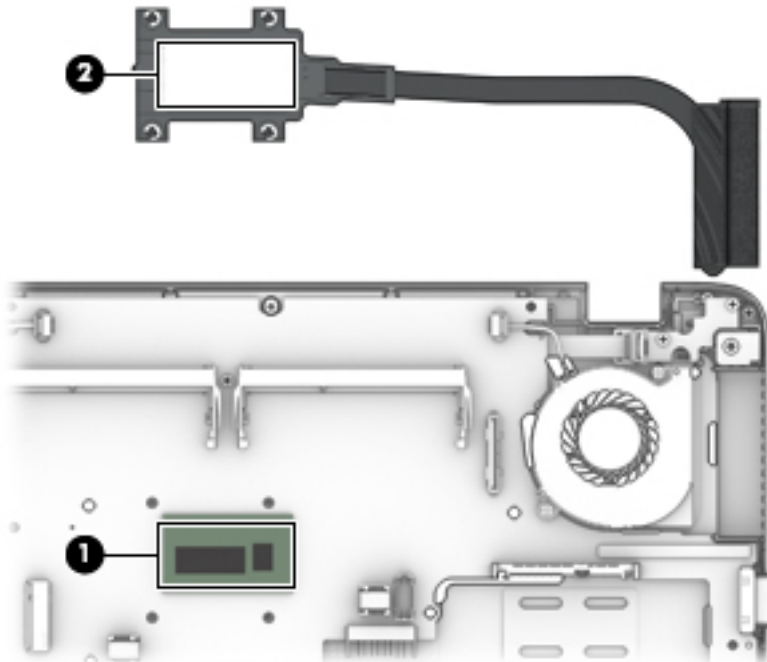

Reverse this procedure to install the heat sink.

# Fan

Description	Spare part number
For use only on computer models equipped with an AMD processor	780895-001
For use only on computer models equipped with an Intel processor	730547-001

Before removing the fan, follow these steps:

1. Turn off the computer. If you are unsure whether the computer is off or in Hibernation, turn the computer on, and then shut it down through the operating system.
2. Disconnect the power from the computer by unplugging the power cord from the computer.
3. Disconnect all external devices from the computer.
4. Remove the service cover (see [Service cover on page 71](#)), and then remove the following components:
  - a. Battery (see [Battery on page 73](#))
  - b. Hard drive (see [Hard drive on page 75](#))
  - c. Keyboard (see [Keyboard on page 85](#))
  - d. Top cover (see [Top cover on page 94](#))
  - e. Heat sink (see [Heat sink on page 111](#))

Remove the fan:

1. Turn the top cover upside down with the front toward you.
2. Disconnect the fan cable **(1)** from the system board.
3. Loosen the two Phillips captive screws **(2)** that secure the fan to the system board.

4. Remove the fan (3).

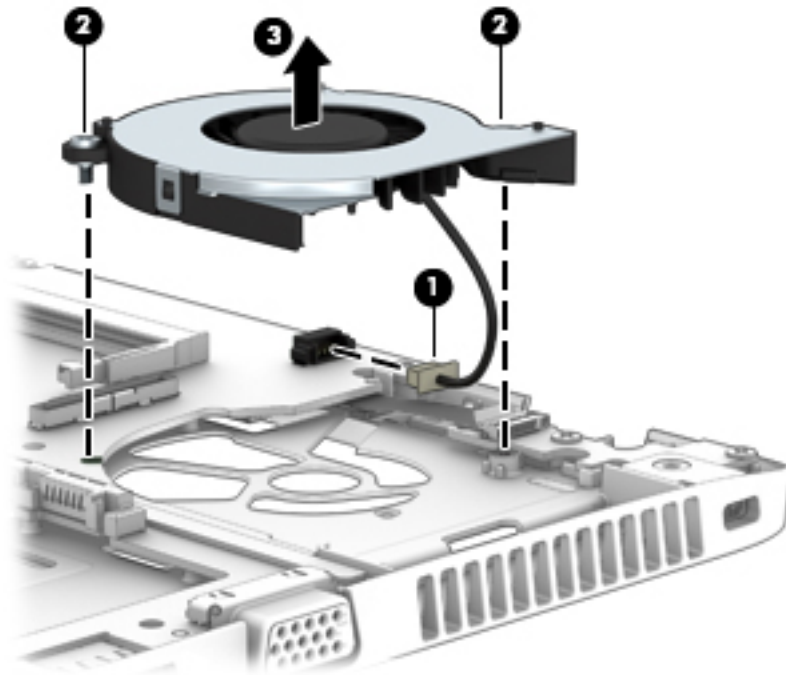

 **NOTE:** The thermal material must be thoroughly cleaned from the surfaces of the heat sink and the system board components each time the heat sink is removed. Replacement thermal material is included with the heat sink and system board spare part kits. Thermal paste is used on the processor (1) and the heat sink section (2) that services it.

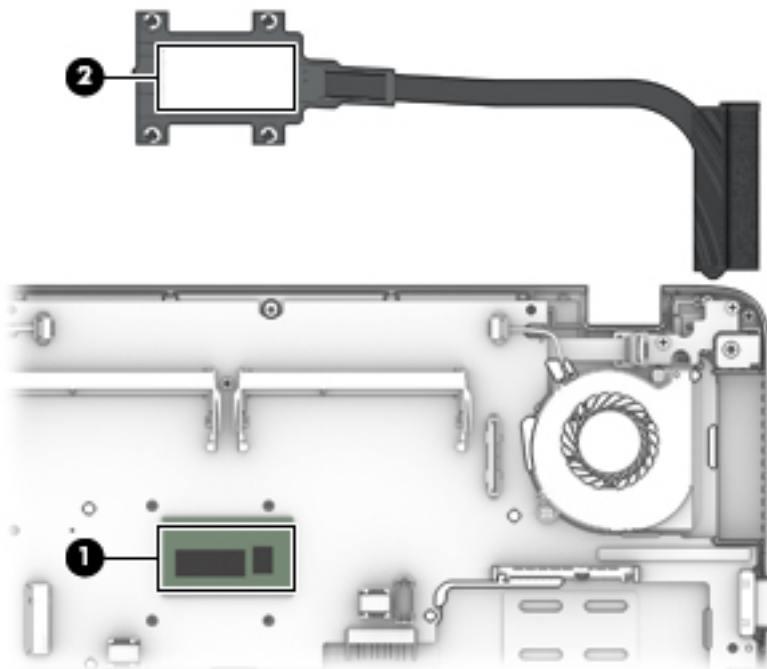

Reverse this procedure to install the fan.

## System board



**NOTE:** The system board spare part kit includes the battery connector bracket and replacement thermal material.

Description	Spare part number
For use only on computer models equipped with an AMD processor:	
Equipped with an AMD A10 Pro-7350B 2.10-GHz (SC turbo up to 3.30-GHz) quad core processor (4.00-MB L2 cache, 19 W), a graphics subsystem with UMA memory, and the Windows 8 Professional operating system	765617-601
Equipped with an AMD A10 Pro-7350B 2.10-GHz (SC turbo up to 3.30-GHz) quad core processor (4.00-MB L2 cache, 19 W), a graphics subsystem with UMA memory, and the Windows 8 Standard operating system	765617-501
Equipped with an AMD A10 Pro-7350B 2.10-GHz (SC turbo up to 3.30-GHz) quad core processor (4.00-MB L2 cache, 19 W), a graphics subsystem with UMA memory, and a non-Windows 8 operating system	765617-001
Equipped with an AMD A8 Pro-7150B 2.00-GHz (SC turbo up to 3.20-GHz) quad core processor (4.00-MB L2 cache, 19 W), a graphics subsystem with UMA memory, and the Windows 8 Professional operating system	765616-601
Equipped with an AMD A8 Pro-7150B 2.00-GHz (SC turbo up to 3.20-GHz) quad core processor (4.00-MB L2 cache, 19 W), a graphics subsystem with UMA memory, and the Windows 8 Standard operating system	765616-501
Equipped with an AMD A8 Pro-7150B 2.00-GHz (SC turbo up to 3.20-GHz) quad core processor (4.00-MB L2 cache, 19 W), a graphics subsystem with UMA memory, and a non-Windows 8 operating system	765616-001
Equipped with an AMD A6 Pro-7050B 2.20-GHz (SC turbo up to 3.00-GHz) dual core processor (1.00-MB L2 cache, 17 W), a graphics subsystem with UMA memory, and the Windows 8 Professional operating system	765615-601
Equipped with an AMD A6 Pro-7050B 2.20-GHz (SC turbo up to 3.00-GHz) dual core processor (1.00-MB L2 cache, 17 W), a graphics subsystem with UMA memory, and the Windows 8 Standard operating system	765615-501
Equipped with an AMD A6 Pro-7050B 2.20-GHz (SC turbo up to 3.00-GHz) dual core processor (1.00-MB L2 cache, 17 W), a graphics subsystem with UMA memory, and a non-Windows 8 operating system	765615-001
For use only on computer models equipped with an Intel processor and a TouchScreen display assembly:	
Equipped with an Intel Core i7-4600U 2.10-GHz (SC turbo up to 3.10-GHz) processor (4.00-MB L3 cache, 15 W) and the Windows 8 Professional operating system	761778-601
Equipped with an Intel Core i7-4600U 2.10-GHz (SC turbo up to 3.10-GHz) processor (4.00-MB L3 cache, 15 W) and the Windows 8 Standard operating system	761778-501
Equipped with an Intel Core i7-4600U 2.10-GHz (SC turbo up to 3.10-GHz) processor (4.00-MB L3 cache, 15 W) and a non-Windows 8 operating system	761778-001
Equipped with an Intel Core i7-4510U 2.00-GHz (SC turbo up to 3.10-GHz) processor (4.00-MB L3 cache, 15 W), a graphics subsystem with UMA memory, and the Windows 8 Professional operating system	778831-601

Description	Spare part number
Equipped with an Intel Core i7-4510U 2.00-GHz (SC turbo up to 3.10-GHz) processor (4.00-MB L3 cache, 15 W), a graphics subsystem with UMA memory, and the Windows 8 Standard operating system	778831-501
Equipped with an Intel Core i7-4510U 2.00-GHz (SC turbo up to 3.10-GHz) processor (4.00-MB L3 cache, 15 W), a graphics subsystem with UMA memory, and a non-Windows 8 operating system	778831-001
Equipped with an Intel Core i7-4500U 1.80-GHz (SC turbo up to 3.00-GHz) processor (4.00-MB L3 cache, 15 W) and the Windows 8 Professional operating system	761777-601
Equipped with an Intel Core i7-4500U 1.80-GHz (SC turbo up to 3.00-GHz) processor (4.00-MB L3 cache, 15 W) and the Windows 8 Standard operating system	761777-501
Equipped with an Intel Core i7-4500U 1.80-GHz (SC turbo up to 3.00-GHz) processor (4.00-MB L3 cache, 15 W) and a non-Windows 8 operating system	761777-001
Equipped with an Intel Core i5-4310U 2.00-GHz (SC turbo up to 3.00-GHz) processor (3.00-MB L3 cache, 15 W), a graphics subsystem with UMA memory, and the Windows 8 Professional operating system	778830-601
Equipped with an Intel Core i5-4310U 2.00-GHz (SC turbo up to 3.00-GHz) processor (3.00-MB L3 cache, 15 W), a graphics subsystem with UMA memory, and the Windows 8 Standard operating system	778830-501
Equipped with an Intel Core i5-4310U 2.00-GHz (SC turbo up to 3.00-GHz) processor (3.00-MB L3 cache, 15 W), a graphics subsystem with UMA memory, and a non-Windows 8 operating system	778830-001
Equipped with an Intel Core i5-4300U 1.90-GHz (SC turbo up to 2.90-GHz) processor (3.00-MB L3 cache, 15 W) and the Windows 8 Professional operating system	761776-601
Equipped with an Intel Core i5-4300U 1.90-GHz (SC turbo up to 2.90-GHz) processor (3.00-MB L3 cache, 15 W) and the Windows 8 Standard operating system	761776-501
Equipped with an Intel Core i5-4300U 1.90-GHz (SC turbo up to 2.90-GHz) processor (3.00-MB L3 cache, 15 W) and a non-Windows 8 operating system	761776-001
Equipped with an Intel Core i5-4210U 1.70-GHz (SC turbo up to 2.70-GHz) processor (3.00-MB L3 cache, 15 W), a graphics subsystem with UMA memory, and the Windows 8 Professional operating system	778829-601
Equipped with an Intel Core i5-4210U 1.70-GHz (SC turbo up to 2.70-GHz) processor (3.00-MB L3 cache, 15 W), a graphics subsystem with UMA memory, and the Windows 8 Standard operating system	778829-501
Equipped with an Intel Core i5-4210U 1.70-GHz (SC turbo up to 2.70-GHz) processor (3.00-MB L3 cache, 15 W), a graphics subsystem with UMA memory, and a non-Windows 8 operating system	778829-001
Equipped with an Intel Core i5-4200U 1.60-GHz (SC turbo up to 2.60-GHz) processor (3.00-MB L3 cache, 15 W) and the Windows 8 Professional operating system	761775-601
Equipped with an Intel Core i5-4200U 1.60-GHz (SC turbo up to 2.60-GHz) processor (3.00-MB L3 cache, 15 W) and the Windows 8 Standard operating system	761775-501
Equipped with an Intel Core i5-4200U 1.60-GHz (SC turbo up to 2.60-GHz) processor (3.00-MB L3 cache, 15 W) and a non-Windows 8 operating system	761775-001
Equipped with an Intel Core i3-4030U 1.90-GHz processor (3.00-MB L3 cache, 15 W), a graphics subsystem with UMA memory, and the Windows 8 Professional operating system	778828-601

<b>Description</b>	<b>Spare part number</b>
Equipped with an Intel Core i3-4030U 1.90-GHz processor (3.00-MB L3 cache, 15 W), a graphics subsystem with UMA memory, and the Windows 8 Standard operating system	778828-501
Equipped with an Intel Core i3-4030U 1.90-GHz processor (3.00-MB L3 cache, 15 W), a graphics subsystem with UMA memory, and a non-Windows 8 operating system	778828-001
For use only on computer models equipped with an Intel processor and a non-TouchScreen display assembly:	
Equipped with an Intel Core i3-4010U 1.70-GHz processor (3.00-MB L3 cache, 15 W), a graphics subsystem with UMA memory, and the Windows 8 Professional operating system	761774-601
Equipped with an Intel Core i3-4010U 1.70-GHz processor (3.00-MB L3 cache, 15 W), a graphics subsystem with UMA memory, and the Windows 8 Standard operating system	761774-501
Equipped with an Intel Core i3-4010U 1.70-GHz processor (3.00-MB L3 cache, 15 W), a graphics subsystem with UMA memory, and a non-Windows 8 operating system	761774-001
For use only on computer models equipped with a non-TouchScreen display assembly:	
Equipped with an Intel Core i7-4600U 2.10-GHz (SC turbo up to 3.30-GHz) processor (4.00-MB L3 cache, 15 W) and the Windows 8 Professional operating system	730559-601
Equipped with an Intel Core i7-4600U 2.10-GHz (SC turbo up to 3.30-GHz) processor (4.00-MB L3 cache, 15 W) and the Windows 8 Standard operating system	730559-501
Equipped with an Intel Core i7-4600U 2.10-GHz (SC turbo up to 3.30-GHz) processor (4.00-MB L3 cache, 15 W) and a non-Windows 8 operating system	730559-001
Equipped with an Intel Core i7-4500U 1.80-GHz (SC turbo up to 3.00-GHz) processor (4.00-MB L3 cache, 15 W) and the Windows 8 Professional operating system	753071-601
Equipped with an Intel Core i7-4500U 1.80-GHz (SC turbo up to 3.00-GHz) processor (4.00-MB L3 cache, 15 W) and the Windows 8 Standard operating system	753071-501
Equipped with an Intel Core i7-4500U 1.80-GHz (SC turbo up to 3.00-GHz) processor (4.00-MB L3 cache, 15 W) and a non-Windows 8 operating system	753071-001
Equipped with an Intel Core i5-4300U 1.90-GHz (SC turbo up to 2.90-GHz) processor (3.00-MB L3 cache, 15 W) and the Windows 8 Professional operating system	731066-601
Equipped with an Intel Core i5-4300U 1.90-GHz (SC turbo up to 2.90-GHz) processor (3.00-MB L3 cache, 15 W) and the Windows 8 Standard operating system	731066-501
Equipped with an Intel Core i5-4300U 1.90-GHz (SC turbo up to 2.90-GHz) processor (3.00-MB L3 cache, 15 W) and a non-Windows 8 operating system	731066-001
Equipped with an Intel Core i5-4200U 1.60-GHz (SC turbo up to 2.60-GHz) processor (3.00-MB L3 cache, 15 W) and the Windows 8 Professional operating system	730558-601
Equipped with an Intel Core i5-4200U 1.60-GHz (SC turbo up to 2.60-GHz) processor (3.00-MB L3 cache, 15 W) and the Windows 8 Standard operating system	730558-501
Equipped with an Intel Core i5-4200U 1.60-GHz (SC turbo up to 2.60-GHz) processor (3.00-MB L3 cache, 15 W) and a non-Windows 8 operating system	730558-001
Equipped with an Intel Core i3-4010U 1.70-GHz processor (3.00-MB L3 cache, 15 W) and the Windows 8 Professional operating system	730557-601

Description	Spare part number
Equipped with an Intel Core i3-4010U 1.70-GHz processor (3.00-MB L3 cache, 15 W) and the Windows 8 Standard operating system	730557-501
Equipped with an Intel Core i3-4010U 1.70-GHz processor (3.00-MB L3 cache, 15 W) and a non-Windows 8 operating system	730557-001

Before removing the system board, follow these steps:

1. Turn off the computer. If you are unsure whether the computer is off or in Hibernation, turn the computer on, and then shut it down through the operating system.
2. Disconnect the power from the computer by unplugging the power cord from the computer.
3. Disconnect all external devices from the computer.
4. Remove the service cover (see [Service cover on page 71](#)), and then remove the following components:
  - a. Battery (see [Battery on page 73](#))
  - b. Hard drive (see [Hard drive on page 75](#))
  - c. Keyboard (see [Keyboard on page 85](#))
  - d. RTC battery (see [RTC battery on page 93](#))
  - e. Top cover (see [Top cover on page 94](#))
  - f. Heat sink (see [Heat sink on page 111](#))
  - g. Fan (see [Fan on page 113](#))

 **NOTE:** When replacing the system board, be sure that the following components are removed from the defective system board and installed on the replacement system board:

- WWAN module (see [WWAN module on page 78](#))
- Solid-state drive (see [Solid-state drive on page 80](#))
- WLAN module (see [WLAN module on page 82](#))
- Memory modules (see [Memory module on page 84](#))

Remove the system board:

1. Turn the top cover upside down with the front toward you.
2. Release the ZIF connector **(1)** to which the power button board cable is attached, and then disconnect the power button board cable from the system board.



3. Release the ZIF connector **(2)** to which the fingerprint reader board cable is attached, and then disconnect the fingerprint reader board cable from the system board.

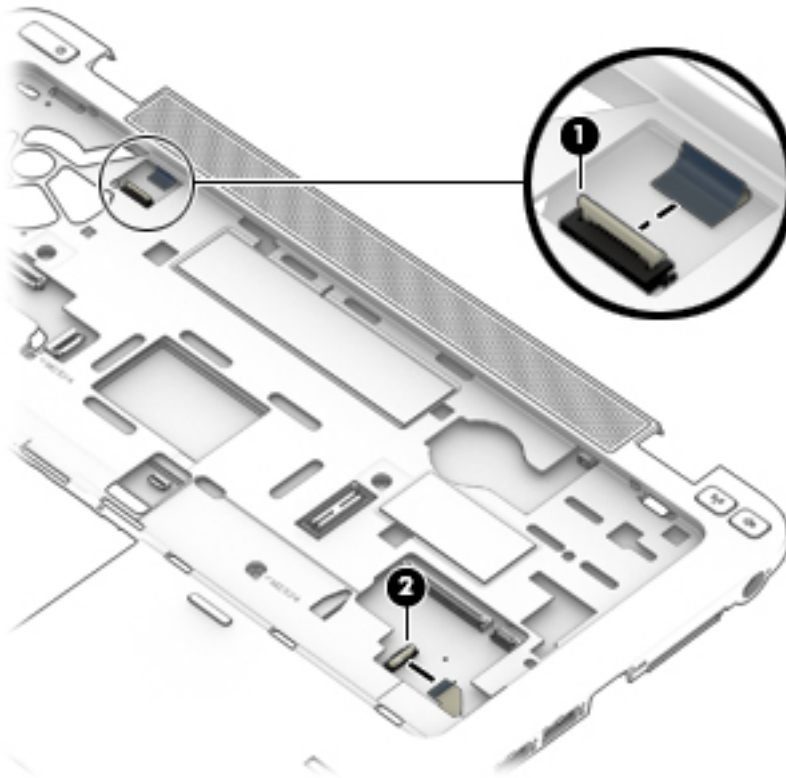

4. Disconnect the speaker cable **(1)** from the system board.
5. Remove the three Phillips PM2.0×3.0 screws **(2)** that secure the system board to the top cover.

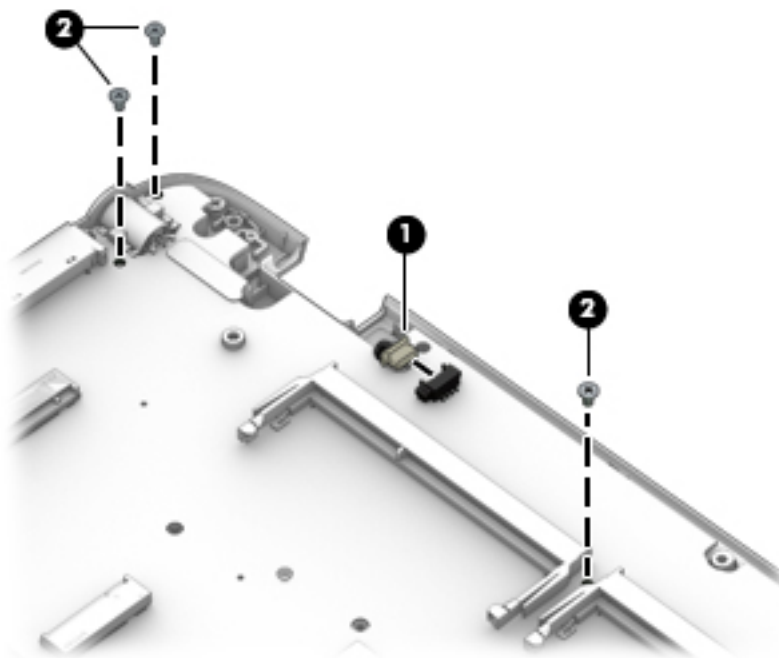

6. Lift up on the right side of the system board **(1)** until it rests at an angle.
7. Remove the system board **(2)** by sliding it up and to the right at an angle.

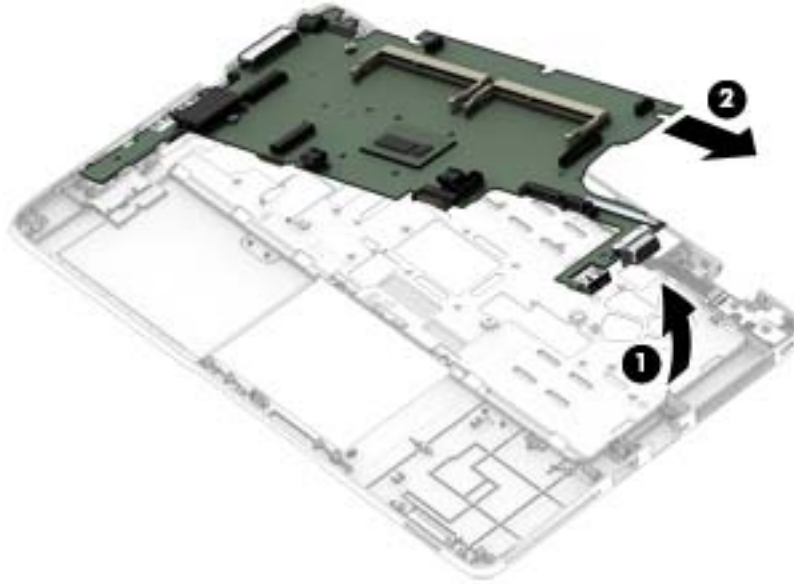

Reverse this procedure to install the system board.

## Fingerprint reader board

Description	Spare part number
Fingerprint reader board (includes bracket and cable)	730554-001

Before removing the fingerprint reader board, follow these steps:

1. Turn off the computer. If you are unsure whether the computer is off or in Hibernation, turn the computer on, and then shut it down through the operating system.
2. Disconnect the power from the computer by unplugging the power cord from the computer.
3. Disconnect all external devices from the computer.
4. Remove the service cover (see [Service cover on page 71](#)), and then remove the following components:
  - a. Battery (see [Battery on page 73](#))
  - b. Hard drive (see [Hard drive on page 75](#))
  - c. Keyboard (see [Keyboard on page 85](#))
  - d. Top cover (see [Top cover on page 94](#))

Remove the fingerprint reader board:

1. Turn the top cover upside down with the front toward you.
2. Detach the fingerprint reader board cable **(1)** from the top cover. (The fingerprint reader board cable is attached to the top cover with double-sided adhesive.)
3. Remove the three Phillips PM2.0×2.5 screws that secure the fingerprint reader board and bracket to the top cover.
4. Remove the fingerprint reader board bracket **(3)**.

5. Remove the fingerprint reader board (4).

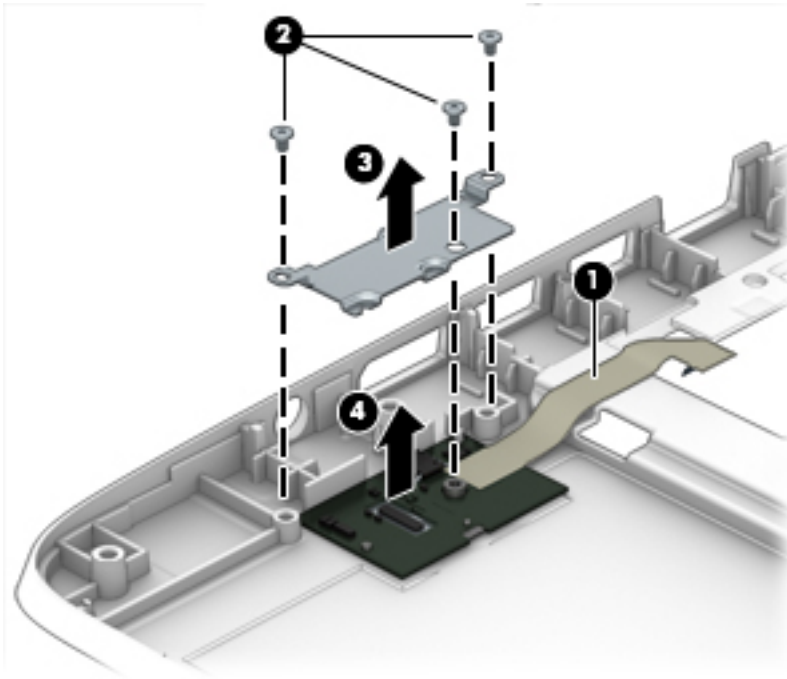

Reverse this procedure to install the fingerprint reader board.

## Speaker assembly

Description	Spare part number
Speaker assembly (includes left and right speakers and cables)	730555-001

Before removing the speaker assembly, follow these steps:

1. Turn off the computer. If you are unsure whether the computer is off or in Hibernation, turn the computer on, and then shut it down through the operating system.
2. Disconnect the power from the computer by unplugging the power cord from the computer.
3. Disconnect all external devices from the computer.
4. Remove the service cover (see [Service cover on page 71](#)), and then remove the following components:
  - a. Battery (see [Battery on page 73](#))
  - b. Hard drive (see [Hard drive on page 75](#))
  - c. Keyboard (see [Keyboard on page 85](#))
  - d. Top cover (see [Top cover on page 94](#))
  - e. System board (see [System board on page 115](#))

Remove the speaker assembly:

1. Release the four clips **(1)** built into the top cover that secure the speaker assembly to the top cover.
2. Remove the speaker assembly **(2)**.

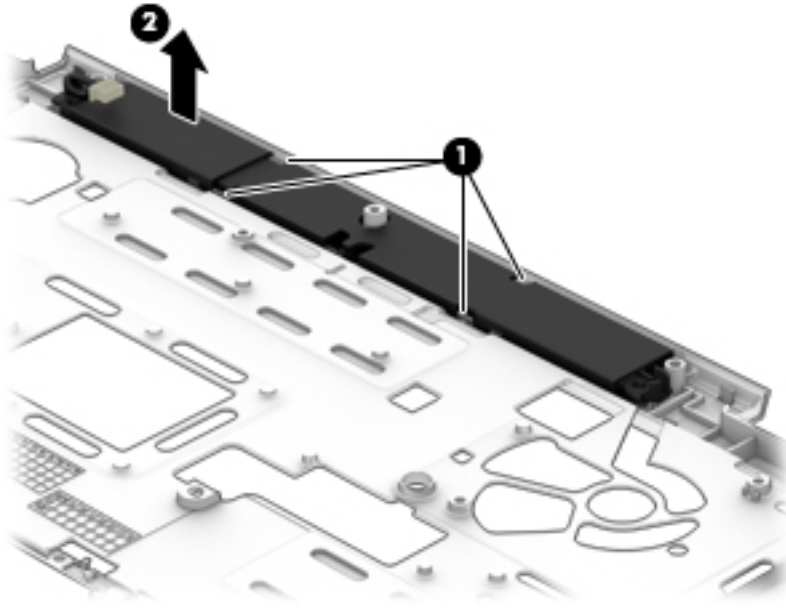

Reverse this procedure to install the speaker assembly.

## Power button board

Description	Spare part number
Power button board (includes cable)	730552-001

Before removing the power button board, follow these steps:

1. Turn off the computer. If you are unsure whether the computer is off or in Hibernation, turn the computer on, and then shut it down through the operating system.
2. Disconnect the power from the computer by unplugging the power cord from the computer.
3. Disconnect all external devices from the computer.
4. Remove the service cover (see [Service cover on page 71](#)), and then remove the following components:
  - a. Battery (see [Battery on page 73](#))
  - b. Hard drive (see [Hard drive on page 75](#))
  - c. Keyboard (see [Keyboard on page 85](#))
  - d. Top cover (see [Top cover on page 94](#))
  - e. System board (see [System board on page 115](#))

Remove the power button board:

1. Remove the two Phillips PM2.0×3.25 screws (**1**) that secure the power button board to the top cover.

2. Remove the power button board **(2)** and cable.

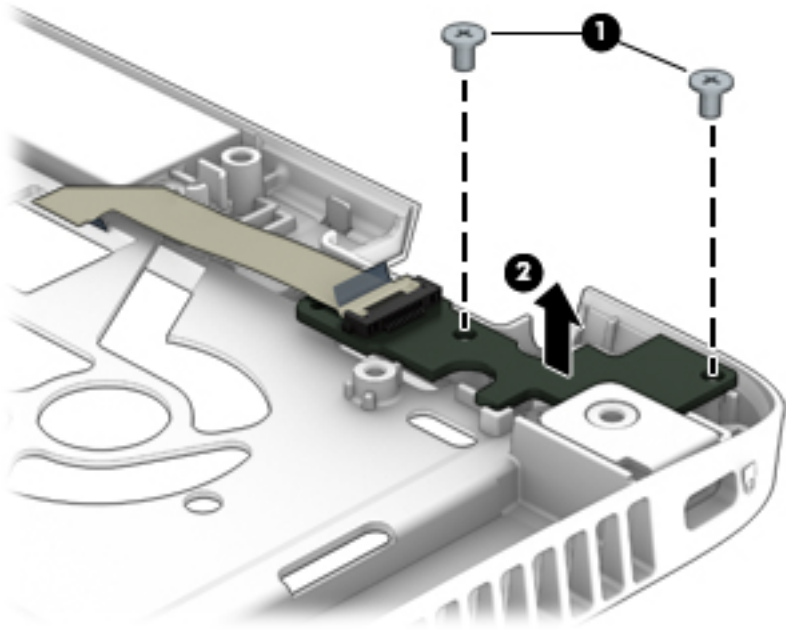

Reverse this procedure to install the power button board.





---

# 7 Computer Setup (BIOS)

## Windows 8 – Computer Setup (BIOS), MultiBoot, and HP PC Hardware Diagnostics (UEFI)

### Using Computer Setup

Computer Setup, or Basic Input/Output System (BIOS), controls communication between all the input and output devices on the system (such as disk drives, display, keyboard, mouse, and printer). Computer Setup includes settings for the types of devices installed, the startup sequence of the computer, and the amount of system and extended memory.

---

 **NOTE:** Use extreme care when making changes in Computer Setup. Errors can prevent the computer from operating properly.

---

### Starting Computer Setup

---

 **NOTE:** An external keyboard or mouse connected to a USB port can be used with Computer Setup only if USB legacy support is enabled.

---

To start Computer Setup, follow these steps:

1. Turn on or restart the computer, and then press **esc** while the “Press the ESC key for Startup Menu” message is displayed at the bottom of the screen.
2. Press **f10** to enter Computer Setup.

## Navigating and selecting in Computer Setup

To navigate and select in Computer Setup, follow these steps:

1. Turn on or restart the computer, and then press **esc** while the “Press the ESC key for Startup Menu” message is displayed at the bottom of the screen.
  - To select a menu or a menu item, use the **tab** key and the keyboard arrow keys and then press **enter**, or use a pointing device to click the item.
  - To scroll up and down, click the up arrow or the down arrow in the upper-right corner of the screen, or use the up arrow key or the down arrow key on the keyboard.
  - To close open dialog boxes and return to the main Computer Setup screen, press **esc**, and then follow the on-screen instructions.



---

**NOTE:** You can use either a pointing device (TouchPad, pointing stick, or USB mouse) or the keyboard to navigate and make selections in Computer Setup.

---

2. Press **f10** to enter Computer Setup.

To exit Computer Setup menus, choose one of the following methods:

- To exit Computer Setup menus without saving your changes:

Click the **Exit** icon in the lower-right corner of the screen, and then follow the on-screen instructions.

– or –

Use the **tab** key and the arrow keys to select **Main > Ignore Changes and Exit**, and then press **enter**.

- To save your changes and exit Computer Setup menus:

Click the **Save** icon in the lower-right corner of the screen, and then follow the on-screen instructions.

– or –

Use the arrow keys to select **Main > Save Changes and Exit**, and then press **enter**.

Your changes go into effect when the computer restarts.

## Restoring factory settings in Computer Setup

 **NOTE:** Restoring defaults will not change the hard drive mode.

---

To return all settings in Computer Setup to the values that were set at the factory, follow these steps:

1. Turn on or restart the computer, and then press **esc** while the “Press the ESC key for Startup Menu” message is displayed at the bottom of the screen.
2. Press **f10** to enter Computer Setup.
3. Use a pointing device or the arrow keys to select **Main > Restore Defaults**.
4. Follow the on-screen instructions.
5. To save your changes and exit, click the **Save** icon in the lower-right corner of the screen, and then follow the on-screen instructions.

– or –

Use the arrow keys to select **Main > Save Changes and Exit**, and then press **enter**.

Your changes go into effect when the computer restarts.

 **NOTE:** Your password settings and security settings are not changed when you restore the factory settings.

---

## Updating the BIOS

Updated versions of the BIOS may be available on the HP website.

Most BIOS updates on the HP website are packaged in compressed files called *SoftPaqs*.

Some download packages contain a file named *Readme.txt*, which contains information regarding installing and troubleshooting the file.

### Determining a BIOS version

To determine whether available BIOS updates contain later BIOS versions than those currently installed on the computer, you need to know the version of the system BIOS currently installed.

BIOS version information (also known as *ROM date* and *System BIOS*) can be displayed by pressing **fn + esc** (if you are already in Windows) or by using Computer Setup.

1. Start Computer Setup.
2. Use a pointing device or the arrow keys to select **Main > System Information**.
3. To exit Computer Setup without saving your changes, click the **Exit** icon in the lower-right corner of the screen, and then follow the on-screen instructions.

– or –

Use the **tab** key and the arrow keys to select **Main > Ignore Changes and Exit**, and then press **enter**.

## Downloading a BIOS update for Windows 8

 **CAUTION:** To reduce the risk of damage to the computer or an unsuccessful installation, download and install a BIOS update only when the computer is connected to reliable external power using the AC adapter. Do not download or install a BIOS update while the computer is running on battery power, docked in an optional docking device, or connected to an optional power source. During the download and installation, follow these instructions:

Do not disconnect power on the computer by unplugging the power cord from the AC outlet.

Do not shut down the computer or initiate Sleep.

Do not insert, remove, connect, or disconnect any device, cable, or cord.

1. From the Start screen, type `support`, and then select the **HP Support Assistant** app.
2. Select **Updates and tune-ups**, and then select **Check for HP updates now**.
3. Follow the on-screen instructions.

 **NOTE:** If you connect your computer to a network, consult the network administrator before installing any software updates, especially system BIOS updates.

4. At the download area, follow these steps:
  - a. Identify the most recent BIOS update and compare it to the BIOS version currently installed on your computer. Make a note of the date, name, or other identifier. You may need this information to locate the update later, after it has been downloaded to your hard drive.
  - b. Follow the on-screen instructions to download your selection to the hard drive.

If the update is more recent than your BIOS, make a note of the path to the location on your hard drive where the BIOS update is downloaded. You will need to access this path when you are ready to install the update.

BIOS installation procedures vary. Follow any instructions that are displayed on the screen after the download is complete. If no instructions are displayed, follow these steps:

1. From the Start screen, type `e`, and then select **File Explorer**.
2. Click your hard drive designation. The hard drive designation is typically Local Disk (C:).
3. Using the hard drive path you recorded earlier, open the folder on your hard drive that contains the update.
4. Double-click the file that has an `.exe` extension (for example, `filename.exe`).

The BIOS installation begins.

5. Complete the installation by following the on-screen instructions.

 **NOTE:** After a message on the screen reports a successful installation, you can delete the downloaded file from your hard drive.

# Using MultiBoot

## About the boot device order

As the computer starts, the system attempts to boot from enabled devices. The MultiBoot utility, which is enabled at the factory, controls the order in which the system selects a boot device. Boot devices can include optical drives, diskette drives, a network interface card (NIC), hard drives, and USB devices. Boot devices contain bootable media or files that the computer needs to start and operate properly.

 **NOTE:** Some boot devices must be enabled in Computer Setup before they can be included in the boot order.

You can change the order in which the computer searches for a boot device by changing the boot order in Computer Setup. You can also press **esc** while the “Press the ESC key for Startup Menu” message is displayed at the bottom of the screen, and then press **f9**. Pressing **f9** displays a menu that shows the current boot devices and allows you to select a boot device. Or, you can use MultiBoot Express to set the computer to prompt you for a boot location each time the computer turns on or restarts.

## Choosing MultiBoot preferences

You can use MultiBoot in the following ways:

- To set a new boot order that the computer uses each time it is turned on, by changing the boot order in Computer Setup.
- To dynamically choose the boot device, by pressing **esc** while the “Press the ESC key for Startup Menu” message is displayed at the bottom of the screen, and then pressing **f9** to enter the Boot Device Options menu.
- To use MultiBoot Express to set variable boot orders. This feature prompts you for a boot device each time the computer is turned on or restarted.

## Setting a new boot order in Computer Setup

To start Computer Setup and set a boot device order that the computer uses each time it is turned on or restarted, follow these steps:

1. Turn on or restart the computer, and then press **esc** while the “Press the ESC key for Startup Menu” message is displayed at the bottom of the screen.
2. Press **f10** to enter Computer Setup.
3. Use a pointing device or the arrow keys to select **Advanced > Boot Options > UEFI Boot Order for UEFI Hybrid or UEFI Native Boot Mode, or select Advanced > Boot Options > Legacy Boot Order for Legacy Boot Mode**, and then press **enter**.
4. To move the device up in the boot order, use a pointing device to click the up arrow, or press the **+** key.

– or –

To move the device down in the boot order, use a pointing device to click the down arrow, or press the **-** key.

5. To save your changes and exit Computer Setup, click the **Save** icon in the lower-left corner of the screen, and then follow the on-screen instructions.

– or –

Use the arrow keys to select **Main > Save Changes and Exit**, and then press [enter](#).

### Dynamically choosing a boot device using the f9 prompt

To dynamically choose a boot device for the current startup sequence, follow these steps:

1. Open the Select Boot Device menu by turning on or restarting the computer, and then pressing **esc** while the “Press the ESC key for Startup Menu” message is displayed at the bottom of the screen.
2. Press **f9**.
3. Use a pointing device or the arrow keys to select a boot device, then press [enter](#).

### Setting a MultiBoot Express prompt

To start Computer Setup and set the computer to display the MultiBoot startup location menu each time the computer is started or restarted, follow these steps:

1. Turn on or restart the computer, and then press [esc](#) while the “Press the ESC key for Startup Menu” message is displayed at the bottom of the screen.
2. Press **f10** to enter Computer Setup.
3. Use a pointing device or the arrow keys to select **Advanced > Boot Options > MultiBoot Express Boot Popup Delay (Sec)**, and then press [enter](#).
4. In the **MultiBoot Express Popup Delay (Sec)** field, enter the length of time in seconds that you want the computer to display the startup location menu before it defaults to the current MultiBoot setting. (When 0 is selected, the Express Boot startup location menu is not displayed.)
5. To save your changes and exit Computer Setup, click the **Save** icon in the lower-left corner of the screen, and then follow the on-screen instructions.

– or –

Use the arrow keys to select **Main > Save Changes and Exit**, and then press [enter](#).

Your changes go into effect when the computer restarts.

## Entering MultiBoot Express preferences

When the Express Boot menu is displayed during startup, you have the following choices:

- To specify a boot device from the Express Boot menu, select your preference within the allotted time, and then press **enter**.
- To prevent the computer from defaulting to the current MultiBoot setting, press any key before the allotted time expires. The computer will not start until you select a boot device and press **enter**.
- To allow the computer to start according to the current MultiBoot settings, wait for the allotted time to expire.

## Using HP PC Hardware Diagnostics (UEFI) (select models only)

HP PC Hardware Diagnostics is a Unified Extensible Firmware Interface (UEFI) that allows you to run diagnostic tests to determine if the computer hardware is functioning properly. The tool runs outside of the operating system to isolate hardware failures from issues that may be caused by the operating system or other software components.

To start HP PC Hardware Diagnostics UEFI:

1. Turn on or restart the computer, quickly press **esc**, and then press **f2**.

After pressing **f2**, the BIOS searches three places for the HP PC Hardware Diagnostics (UEFI) tools in the following order:

- a. Connected USB drive



**NOTE:** To download the HP PC Hardware Diagnostics (UEFI) tool to a USB drive, see [Downloading HP PC Hardware Diagnostics \(UEFI\) to a USB device on page 134](#).

- b. Hard drive
- c. BIOS

2. Click the type of diagnostic test you want to run, and then follow the on-screen instructions.



**NOTE:** If you need to stop a diagnostic test while it is running, press **esc**.

## Downloading HP PC Hardware Diagnostics (UEFI) to a USB device

 **NOTE:** The HP PC Hardware Diagnostics (UEFI) download instructions are provided in English only.

---

1. Go to <http://www.hp.com>.
2. Click **Support & Drivers**, and then click the **Drivers & Software** tab.
3. Enter the product name in the text box, and then click **Search**.
4. Select your computer model, and then select your operating system.
5. In the Diagnostic section, click **HP UEFI Support Environment**.

– or –

Click **Download**, and then select **Run**.



# Windows 7 – Computer Setup (BIOS), MultiBoot, and HP PC Hardware Diagnostics (UEFI)

## Using Computer Setup

Computer Setup, or Basic Input/Output System (BIOS), controls communication between all the input and output devices on the system (such as disk drives, display, keyboard, mouse, and printer). Computer Setup includes settings for the types of devices installed, the startup sequence of the computer, and the amount of system and extended memory.

---

 **NOTE:** Use extreme care when making changes in Computer Setup. Errors can prevent the computer from operating properly.

---

## Starting Computer Setup

---

 **NOTE:** An external keyboard or mouse connected to a USB port can be used with Computer Setup only if USB legacy support is enabled.

---

To start Computer Setup, follow these steps:

1. Turn on or restart the computer, and then press **esc** while the “Press the ESC key for Startup Menu” message is displayed at the bottom of the screen.
2. Press **f10** to enter Computer Setup.

## Navigating and selecting in Computer Setup

To navigate and select in Computer Setup, follow these steps:

1. Turn on or restart the computer, and then press **esc** while the “Press the ESC key for Startup Menu” message is displayed at the bottom of the screen.

---

 **NOTE:** You can use either a pointing device (TouchPad, pointing stick, or USB mouse) or the keyboard to navigate and make selections in Computer Setup.

---

2. Press **f10** to enter Computer Setup.
  - To select a menu or a menu item, use the **tab** key and the keyboard arrow keys and then press **enter**, or use a pointing device to click the item.
  - To scroll up and down, click the up arrow or the down arrow in the upper-right corner of the screen, or use the up arrow key or the down arrow key on the keyboard.
  - To close open dialog boxes and return to the main Computer Setup screen, press **esc**, and then follow the on-screen instructions.

To exit Computer Setup menus, choose one of the following methods:

- To exit Computer Setup menus without saving your changes:

Click the **Exit** icon in the lower-right corner of the screen, and then follow the on-screen instructions.

– or –

Use the **tab** key and the arrow keys to select **File > Ignore Changes and Exit**, and then press **enter**.

- To save your changes and exit Computer Setup menus:

Click the **Save** icon in the lower-right corner of the screen, and then follow the on-screen instructions.

– or –

Use the **tab** key and the arrow keys to select **File > Ignore Changes and Exit**, and then press **enter**.

Your changes go into effect when the computer restarts.

## Restoring factory settings in Computer Setup

---

 **NOTE:** Restoring defaults will not change the hard drive mode.

---

To return all settings in Computer Setup to the values that were set at the factory, follow these steps:

1. Turn on or restart the computer, and then press **esc** while the “Press the ESC key for Startup Menu” message is displayed at the bottom of the screen.
2. Press **f10** to enter Computer Setup.
3. Use a pointing device or the arrow keys to select **File > Restore Defaults**.
4. Follow the on-screen instructions.
5. To save your changes and exit, click the **Save** icon in the lower-right corner of the screen, and then follow the on-screen instructions.

– or –

Use the arrow keys to select **File > Save Changes and Exit**, and then press **enter**.

Your changes go into effect when the computer restarts.

---

 **NOTE:** Your password settings and security settings are not changed when you restore the factory settings.

---

## Updating the BIOS

Updated versions of the BIOS may be available on the HP website.

Most BIOS updates on the HP website are packaged in compressed files called *SoftPaqs*.

Some download packages contain a file named *Readme.txt*, which contains information regarding installing and troubleshooting the file.

## Determining a BIOS version

To determine whether available BIOS updates contain later BIOS versions than those currently installed on the computer, you need to know the version of the system BIOS currently installed.

BIOS version information (also known as *ROM date* and *System BIOS*) can be displayed by pressing **fn** + **esc** (if you are already in Windows) or by using Computer Setup.

1. Start Computer Setup.
2. Use a pointing device or the arrow keys to select **File > System Information**.
3. To exit Computer Setup without saving your changes, click the **Exit** icon in the lower-right corner of the screen, and then follow the on-screen instructions.

– or –

Use the **tab** key and the arrow keys to select **File > Ignore Changes and Exit**, and then press **enter**.

## Downloading a BIOS update for Windows 7

 **CAUTION:** To reduce the risk of damage to the computer or an unsuccessful installation, download and install a BIOS update only when the computer is connected to reliable external power using the AC adapter. Do not download or install a BIOS update while the computer is running on battery power, docked in an optional docking device, or connected to an optional power source. During the download and installation, follow these instructions:

Do not disconnect power on the computer by unplugging the power cord from the AC outlet.

Do not shut down the computer or initiate Sleep.

Do not insert, remove, connect, or disconnect any device, cable, or cord.

1. Access Help and Support by selecting **Start > Help and Support**.
2. Select **Updates and tune-ups**, and then select **Check for HP updates now**.
3. At the download area, follow these steps:
  - a. Identify the most recent BIOS update and compare it to the BIOS version currently installed on your computer. Make a note of the date, name, or other identifier. You may need this information to locate the update later, after it has been downloaded to your hard drive.
  - b. Follow the on-screen instructions to download your selection to the hard drive.

If the update is more recent than your BIOS, make a note of the path to the location on your hard drive where the BIOS update is downloaded. You will need to access this path when you are ready to install the update.

 **NOTE:** If you connect your computer to a network, consult the network administrator before installing any software updates, especially system BIOS updates.

BIOS installation procedures vary. Follow any instructions that are displayed on the screen after the download is complete. If no instructions are displayed, follow these steps:

1. Select **Start > Computer**.
2. Click your hard drive designation. The hard drive designation is typically Local Disk (C:).
3. Using the hard drive path you recorded earlier, open the folder on your hard drive that contains the update.
4. Double-click the file that has an .exe extension (for example, *filename.exe*).

The BIOS installation begins.
5. Complete the installation by following the on-screen instructions.

 **NOTE:** After a message on the screen reports a successful installation, you can delete the downloaded file from your hard drive.

# Using MultiBoot

## About the boot device order

As the computer starts, the system attempts to boot from enabled devices. The MultiBoot utility, which is enabled at the factory, controls the order in which the system selects a boot device. Boot devices can include optical drives, diskette drives, a network interface card (NIC), hard drives, and USB devices. Boot devices contain bootable media or files that the computer needs to start and operate properly.

 **NOTE:** Some boot devices must be enabled in Computer Setup before they can be included in the boot order.

You can change the order in which the computer searches for a boot device by changing the boot order in Computer Setup. You can also press `esc` while the “Press the ESC key for Startup Menu” message is displayed at the bottom of the screen, and then press `f9`. Pressing `f9` displays a menu that shows the current boot devices and allows you to select a boot device. Or, you can use MultiBoot Express to set the computer to prompt you for a boot location each time the computer turns on or restarts.

## Choosing MultiBoot preferences

You can use MultiBoot in the following ways:

- To set a new boot order that the computer uses each time it is turned on, by changing the boot order in Computer Setup.
- To dynamically choose the boot device, by pressing `esc` while the “Press the ESC key for Startup Menu” message is displayed at the bottom of the screen, and then pressing `f9` to enter the Boot Device Options menu.
- To use MultiBoot Express to set variable boot orders. This feature prompts you for a boot device each time the computer is turned on or restarted.

## Setting a new boot order in Computer Setup

To start Computer Setup and set a boot device order that the computer uses each time it is turned on or restarted, follow these steps:

1. Turn on or restart the computer, and then press `esc` while the “Press the ESC key for Startup Menu” message is displayed at the bottom of the screen.
2. Press `f10` to enter Computer Setup.
3. Use a pointing device or the arrow keys to select the **Legacy Boot Order** list, and then press `enter`.
4. To move the device up in the boot order, use a pointing device to click the up arrow, or press the `+` key.

– or –

To move the device down in the boot order, use a pointing device to click the down arrow, or press the `-` key.

5. To save your changes and exit Computer Setup, click the **Save** icon in the lower-left corner of the screen, and then follow the on-screen instructions.

– or –

Use the arrow keys to select **File > Save Changes and Exit**, and then press `enter`.

### Dynamically choosing a boot device using the `f9` prompt

To dynamically choose a boot device for the current startup sequence, follow these steps:

1. Open the Select Boot Device menu by turning on or restarting the computer, and then pressing `esc` while the “Press the ESC key for Startup Menu” message is displayed at the bottom of the screen.
2. Press `f9`.
3. Use a pointing device or the arrow keys to select a boot device, then press `enter`.

### Setting a MultiBoot Express prompt

To start Computer Setup and set the computer to display the MultiBoot startup location menu each time the computer is started or restarted, follow these steps:

1. Turn on or restart the computer, and then press `esc` while the “Press the ESC key for Startup Menu” message is displayed at the bottom of the screen.
2. Press `f10` to enter Computer Setup.
3. Use a pointing device or the arrow keys to select **System Configuration > Boot Options**, and then press `enter`.
4. In the **MultiBoot Express Popup Delay (Sec)** field, enter the length of time in seconds that you want the computer to display the startup location menu before it defaults to the current MultiBoot setting. (When 0 is selected, the Express Boot startup location menu is not displayed.)
5. To save your changes and exit Computer Setup, click the **Save** icon in the lower-left corner of the screen, and then follow the on-screen instructions.

– or –

Use the arrow keys to select **File > Save Changes and Exit**, and then press `enter`.

Your changes go into effect when the computer restarts.

## Entering MultiBoot Express preferences

When the Express Boot menu is displayed during startup, you have the following choices:

- To specify a boot device from the Express Boot menu, select your preference within the allotted time, and then press **enter**.
- To prevent the computer from defaulting to the current MultiBoot setting, press any key before the allotted time expires. The computer will not start until you select a boot device and press **enter**.
- To allow the computer to start according to the current MultiBoot settings, wait for the allotted time to expire.

## Using HP PC Hardware Diagnostics (UEFI) (select models only)

HP PC Hardware Diagnostics is a Unified Extensible Firmware Interface (UEFI) that allows you to run diagnostic tests to determine if the computer hardware is functioning properly. The tool runs outside of the operating system to isolate hardware failures from issues that may be caused by the operating system or other software components.

To start HP PC Hardware Diagnostics UEFI:

1. Turn on or restart the computer, quickly press **esc**, and then press **f2**.

After pressing **f2**, the BIOS searches three places for the HP PC Hardware Diagnostics (UEFI) tools in the following order:

- a. Connected USB drive



**NOTE:** To download the HP PC Hardware Diagnostics (UEFI) tool to a USB drive, see [Downloading HP PC Hardware Diagnostics \(UEFI\) to a USB device on page 142](#).

- b. Hard drive
- c. BIOS

2. Click the type of diagnostic test you want to run, and then follow the on-screen instructions.



**NOTE:** If you need to stop a diagnostic test while it is running, press **esc**.

## Downloading HP PC Hardware Diagnostics (UEFI) to a USB device

 **NOTE:** The HP PC Hardware Diagnostics (UEFI) download instructions are provided in English only.

---

1. Go to <http://www.hp.com>.
2. Click **Support & Drivers**, and then click the **Drivers & Software** tab.
3. Enter the product name in the text box, and then click **Search**.
4. Select your computer model, and then select your operating system.
5. In the Diagnostic section, click **HP UEFI Support Environment**.

– or –

Click **Download**, and then select **Run**.



# Linux – Computer Setup (BIOS) and Advanced System Diagnostics

Computer Setup, or Basic Input/Output System (BIOS), controls communication between all the input and output devices on the system (such as disk drives, display, keyboard, mouse, and printer). Computer Setup includes settings for the types of peripherals installed, the startup sequence of the computer, and the amount of system and extended memory.

 **NOTE:** Use extreme care when making changes in Computer Setup. Errors can prevent the computer from operating properly.

---

## Starting Computer Setup

 **NOTE:** An external keyboard or mouse connected to a USB port can be used with Computer Setup only if USB legacy support is enabled.

---

To start Computer Setup, follow these steps:

1. Turn on or restart the computer, and then press **esc** while the “Press the ESC key for Startup Menu” message is displayed at the bottom of the screen.
2. Press **f10** to enter Computer Setup.

## Using Computer Setup

### Navigating and selecting in Computer Setup

To navigate and select in Computer Setup, follow these steps:

1. Turn on or restart the computer, and then press **esc** while the “Press the ESC key for Startup Menu” message is displayed at the bottom of the screen.
  - To select a menu or a menu item, use the **tab** key and the keyboard arrow keys and then press **enter**, or use a pointing device to click the item.
  - To scroll up and down, click the up arrow or the down arrow in the upper-right corner of the screen, or use the up arrow key or the down arrow key.
  - To close open dialog boxes and return to the main Computer Setup screen, press **esc**, and then follow the on-screen instructions.

 **NOTE:** You can use either a pointing device (TouchPad, pointing stick, or USB mouse) or the keyboard to navigate and make selections in Computer Setup.

---

2. Press **f10** to enter Computer Setup.

To exit Computer Setup menus, choose one of the following methods:

- To exit Computer Setup menus without saving your changes, click the **Exit** icon in the lower-left corner of the screen, and then follow the on-screen instructions.

– or –

Use the **tab** key and the arrow keys to select **File > Ignore Changes and Exit**, and then press **enter**.

– or –

- To save your changes and exit Computer Setup menus, click the **Save** icon in the lower-left corner of the screen, and then follow the on-screen instructions.

– or –

Use the **tab** key and the arrow keys to select **File > Save Changes and Exit**, and then press **enter**.

Your changes go into effect when the computer restarts.

## Restoring factory settings in Computer Setup

---

 **NOTE:** Restoring defaults will not change the hard drive mode.

---

To return all settings in Computer Setup to the values that were set at the factory, follow these steps:

1. Turn on or restart the computer, and then press **esc** while the “Press the ESC key for Startup Menu” message is displayed at the bottom of the screen.
2. Press **f10** to enter Computer Setup.
3. Use a pointing device or the arrow keys to select **File > Restore Defaults**.
4. Follow the on-screen instructions.
5. To save your changes and exit, click the **Save** icon in the lower-left corner of the screen, and then follow the on-screen instructions.

– or –

Use the arrow keys to select **File > Save Changes and Exit**, and then press **enter**.

Your changes go into effect when the computer restarts.

---

 **NOTE:** Your password settings and security settings are not changed when you restore the factory settings.

---

## Updating the BIOS

Updated versions of the BIOS may be available on the HP Web site.

Most BIOS updates on the HP Web site are packaged in compressed files called *SoftPaqs*.

Some download packages contain a file named *Readme.txt*, which contains information regarding installing and troubleshooting the file.

## Determining the BIOS version

To determine whether available BIOS updates contain later BIOS versions than those currently installed on the computer, you need to know the version of the system BIOS currently installed.

BIOS version information (also known as *ROM date* and *System BIOS*) can be displayed as follows:

1. Start Computer Setup.
2. Use a pointing device or the arrow keys to select **File > System Information**.
3. To exit Computer Setup without saving your changes, click the **Exit** icon in the lower-left corner of the screen, and then follow the on-screen instructions.

– or –

Use the **tab** key and the arrow keys to select **File > Ignore Changes and Exit**, and then press **enter**.



**NOTE:** You can also determine the BIOS version by turning on or restarting the computer, pressing the **esc** key while the “Press the ESC key for Startup Menu” message is displayed at the bottom of the screen, and then pressing the **f1** key. Follow the on-screen instructions to exit this screen.

## Downloading a BIOS update

**CAUTION:** To reduce the risk of damage to the computer or an unsuccessful installation, download and install a BIOS update only when the computer is connected to reliable external power using the AC adapter. Do not download or install a BIOS update while the computer is running on battery power, docked in an optional docking device, or connected to an optional power source. During the download and installation, follow these instructions:

Do not disconnect power from the computer by unplugging the power cord from the AC outlet.

Do not shut down the computer or initiate Suspend or Hibernation.

Do not insert, remove, connect, or disconnect any device, cable, or cord.

1. Open your web browser. For U.S. support, go to <http://www.hp.com/go/contactHP>. For worldwide support, go to [http://welcome.hp.com/country/us/en/wwcontact\\_us.html](http://welcome.hp.com/country/us/en/wwcontact_us.html).
2. Follow the on-screen instructions to identify your computer and access the BIOS update you want to download.
3. Click the option for software and driver downloads, type your computer model number in the product box, and then press **enter**. Follow the on-screen instructions to identify your computer and access the BIOS update you want to download.

4. Click your specific product from the models listed.
5. Click the appropriate operating system.
6. Go to the BIOS section and download the BIOS software package.
7. Follow the installation instructions as provided with the downloaded BIOS software package.



**NOTE:** After a message on the screen reports a successful installation, you can delete the downloaded file from your hard drive.

---

## Using Advanced System Diagnostics

Advanced System Diagnostics allows you to run diagnostic tests to determine if the computer hardware is functioning properly. The following diagnostic tests are available in Advanced System Diagnostics:

- Start-up test—This test analyzes the main computer components that are required to start the computer.
- Run-in test—This test repeats the start-up test and checks for intermittent problems that the startup test does not detect.
- Hard disk test—This test analyzes the physical condition of the hard drive, and then checks all data in every sector of the hard drive. If the test detects a damaged sector, it attempts to move the data to a good sector.
- Memory test—This test analyzes the physical condition of the memory modules. If it reports an error, replace the memory modules immediately.
- Battery test—This test analyzes the condition of the battery and calibrates the battery if necessary. If the battery fails the test, contact support to report the issue and purchase a replacement battery.
- System Tune-Up—This group of additional tests checks your computer to make sure that the main components are functioning correctly. System Tune-Up runs longer and more comprehensive tests on memory modules, hard drive SMART attributes, the hard drive surface, the battery (and battery calibration), video memory, and the WLAN module status.

You can view system information and error logs in the Advanced System Diagnostics window.

To start Advanced System Diagnostics:

1. Turn on or restart the computer. While the “Press the ESC key for Startup Menu” message is displayed in the lower-left corner of the screen, press **esc**. When the Startup Menu is displayed, press **f2**.
2. Click the diagnostic test you want to run, and then follow the on-screen instructions.



**NOTE:** If you need to stop a diagnostics test while it is running, press **esc**.

---

# 8 Specifications

	Metric	U.S.
<b>Dimensions</b>		
Width	<b>21.0 cm</b>	12.2 in
Depth	<b>21.5 cm</b>	8.5 in
Height	<b>2.1 cm</b>	0.83 in
Equipped with 3-cell, 26-WHr battery, 1 memory module, WLAN module, lightest solid-state module, but without fingerprint reader, webcam, or WWAN module	<b>1.33 kg</b>	2.93 lb
Equipped with 3-cell, 46-WHr battery, 1 memory module, WLAN module, lightest solid-state module, but without fingerprint reader, webcam, or WWAN module	<b>1.42 kg</b>	3.13 lb
Operating voltage and current	19.5 V dc @ 2.31 A - 45 W	
	19.5 V dc @ 3.33 A - 65 W	
<b>Temperature</b>		
Operating	<b>5°C to 35°C</b>	41°F to 95°F
Nonoperating	<b>-20°C to 60°C</b>	-4°F to 140°F
<b>Relative humidity</b> (non-condensing)		
Operating	10% to 90%	
Nonoperating	5% to 95%	
<b>Maximum altitude</b> (unpressurized)		
Operating	<b>-15 m to 3,048 m</b>	-50 ft to 10,000 ft
Nonoperating	<b>-15 m to 12,192 m</b>	-50 ft to 40,000 ft
<b>NOTE:</b> Applicable product safety standards specify thermal limits for plastic surfaces. The device operates well within this range of temperatures.		



---

# 9 Backup and recovery

## Windows 8

To protect your information, use Windows backup and restore utilities to back up individual files and folders, back up your entire hard drive, create system repair media (select models only) by using the installed optical drive (select models only) or an optional external optical drive, or create system restore points. In case of system failure, you can use the backup files to restore the contents of your computer.

From the Start screen, type `restore`, click **Settings**, and then select from the list of displayed options.

 **NOTE:** For detailed instructions on various backup and restore options, perform a search for these topics in HP Support Assistant. To access HP Support Assistant on the Start screen, select the **HP Support Assistant** app.

In case of system instability, HP recommends that you print the recovery procedures and save them for later use.

 **NOTE:** Windows includes the User Account Control feature to improve the security of your computer. You may be prompted for your permission or password for tasks such as installing software, running utilities, or changing Windows settings. Refer to HP Support Assistant. To access HP Support Assistant on the Start screen, select the **HP Support Assistant** app.

## Backing up your information

Recovery after a system failure is as good as your most recent backup. You should create system repair media and your initial backup immediately after initial system setup. As you add new software and data files, you should continue to back up your system on a regular basis to maintain a reasonably current backup. The system repair media (select models only) are used to start up (boot) the computer and repair the operating system in case of system instability or failure. Your initial and subsequent backups allow you to restore your data and settings if a failure occurs.

On the Start screen, type `backup`, click **Settings**, and then select **Save backup copies of your files with File History**.

You can back up your information to an optional external hard drive or a network drive.

Note the following when backing up:

- Store personal files in the Documents library, and back it up regularly.
- Back up templates that are stored in their associated programs.
- Save customized settings that appear in a window, toolbar, or menu bar by taking a screen shot of your settings. The screen shot can be a time-saver if you have to reset your preferences.

To create a backup using Backup and Restore:

---

 **NOTE:** Be sure that the computer is connected to AC power before you start the backup process.

 **NOTE:** The backup process may take over an hour, depending on file size and the speed of the computer.

---

1. From the Start screen, type `backup`, click **Settings**, and then select from the list of displayed options.
2. Follow the on-screen instructions to set up your backup, create a system image (select models only), or create system repair media (select models only).

## Performing a system recovery

In case of system failure or instability, the computer provides the following tools to recover your files:

- Windows recovery tools: You can use Windows Backup and Restore to recover information you have previously backed up. You can also use Windows Automatic Repair to fix problems that might prevent Windows from starting correctly.
- `f11` recovery tools: You can use the `f11` recovery tools to recover your original hard drive image. The image includes the Windows operating system and software programs installed at the factory.

---

 **NOTE:** If you are unable to boot (start up) your computer and you cannot use the system repair media you previously created (select models only), you must purchase Windows 8 operating system media to reboot the computer and repair the operating system. For additional information, see [Using Windows 8 operating system media \(purchased separately\) on page 152](#).

---



## Using the Windows recovery tools

To recover information you previously backed up:

- ▲ Access HP Support Assistant. To access HP Support Assistant on the Start screen, select the **HP Support Assistant** app.

To recover your information using Automatic Repair, follow these steps:

---

 **CAUTION:** Some Automatic Repair options will completely erase and reformat the hard drive. All files you have created and any software installed on the computer are permanently removed. When reformatting is complete, the recovery process restores the operating system, as well as the drivers, software, and utilities from the backup used for recovery.

---

1. If possible, back up all personal files.
2. If possible, check for the presence of the Recovery Image partition and the Windows partition.

From the Start screen, type *e*, and then click **File Explorer**.

– or –

From the Start screen, type *c*, and then select **Computer**.

---

 **NOTE:** If the Windows partition and the Recovery Image partition are not listed, you must recover your operating system and programs using the Windows 8 operating system DVD and the Driver Recovery media (both purchased separately). For additional information, see [Using Windows 8 operating system media \(purchased separately\) on page 152](#).

---

3. If the Windows partition and the Recovery Image partition are listed, restart the computer. After Windows has loaded, press and hold the **shift** key while clicking **Restart**.
4. Select **Troubleshoot**, then select **Advanced Options**, and then select **Automatic Repair**.
5. Follow the on-screen instructions.

---

 **NOTE:** For additional information on recovering information using the Windows tools, perform a search for these topics in HP Support Assistant. To access HP Support Assistant on the Start screen, select the **HP Support Assistant** app.

---

## Using f11 recovery tools

---

 **CAUTION:** Using **f11** completely erases hard drive contents and reformats the hard drive. All files that you have created and any software that you have installed on the computer are permanently removed. The **f11** recovery tool reinstalls the operating system and HP programs and drivers that were installed at the factory. Software not installed at the factory must be reinstalled.

---

To recover the original hard drive image using **f11**:

1. If possible, back up all personal files.
2. If possible, check for the presence of the HP Recovery partition: From the Start screen, type **C**, and then select **Computer**.

 **NOTE:** If the Recovery Image partition is not listed, you must recover your operating system and programs using the Windows 8 operating system media and the Driver Recovery media (both purchased separately). For additional information, see [Using Windows 8 operating system media \(purchased separately\) on page 152](#).

---

3. If the Recovery Image partition is listed, restart the computer, and then press **esc** while the “Press the ESC key for Startup Menu” message is displayed at the bottom of the screen.
4. Press **f11** while the “Press <F11> for recovery” message is displayed on the screen.
5. Follow the on-screen instructions.

## Using Windows 8 operating system media (purchased separately)

---

 **NOTE:** Your computer may not come equipped with an internal optical drive. In order to use the operating system DVD, you may need to plug in an external optical drive.

---

To order a Windows 8 operating system DVD, go to <http://www.hp.com/support>, select your country or region, and follow the on-screen instructions. You can also order the DVD by calling support. For contact information, see the *Worldwide Telephone Numbers* booklet included with the computer.

---

 **CAUTION:** Using a Windows 8 operating system media completely erases hard drive contents and reformats the hard drive. All files that you have created and any software that you have installed on the computer are permanently removed. When reformatting is complete, the recovery process helps you restore the operating system, as well as drivers, software, and utilities.

---

To initiate recovery using a Windows 8 operating system DVD:

 **NOTE:** This process takes several minutes.

---

1. If possible, back up all personal files.
2. Restart the computer, and then insert the Windows 8 operating system DVD into the optical drive before the Windows operating system loads.
3. When prompted, press any keyboard key.
4. Follow the on-screen instructions.

After the installation is completed:

1. Eject the Windows 8 operating system media and then insert the *Driver Recovery* media.
2. Install the Hardware Enabling Drivers first, and then install Recommended Applications.

## Using Windows Refresh for quick and easy recovery

When your computer is not working properly and you need to regain system stability, the Windows Refresh option allows you to start fresh and keep what is important to you.

 **IMPORTANT:** Refresh removes any traditional applications that were not originally installed on the system at the factory.

 **NOTE:** During Refresh, a list of removed traditional applications will be saved so that you have a quick way to see what you might need to reinstall. See HP Support Assistant for instructions on reinstalling traditional applications. To access HP Support Assistant on the Start screen, select the **HP Support Assistant** app.

 **NOTE:** You may be prompted for your permission or password when using Refresh. See HP Support Assistant for more information. To access HP Support Assistant on the Start screen, select the **HP Support Assistant** app.

To start Refresh:

1. On the Start screen, point to the far-right upper or lower corner of the screen to display the charms.
2. Click **Settings**.

## Remove everything and reinstall Windows

Sometimes you want to perform detailed reformatting of your computer, or you want to remove personal information before you give away or recycle your computer. The process described in this section provides a speedy, simple way to return the computer to its original state. This option removes all personal data, apps, and settings from your computer, and reinstalls Windows.

 **IMPORTANT:** This option does not provide backups of your information. Before using this option, back up any personal information you wish to retain.

You can initiate this option by using the **f11** key or from the Start screen.

To use the **f11** key:

1. Press **f11** while the computer boots.  
– or –  
Press and hold **f11** as you press the power button.
2. Choose your language.
3. Choose your keyboard layout.

4. Select **Troubleshoot** from the boot options menu.
5. Select **Reset your PC**, and follow the on-screen instructions.

To use the Start screen:

1. On the Start screen, point to the far-right upper or lower corner of the screen to display the charms.
2. Click **Settings**.
3. Click **Change PC settings** in the bottom-right corner of the screen, and then select **General** from the PC settings screen.
4. Scroll the right-side choices down to display **Remove everything and reinstall Windows**.
5. Under **Remove everything and reinstall Windows**, select **Get started**, and follow the onscreen instructions.

## Using HP Software Setup

HP Software Setup can be used to reinstall drivers or select software that has been corrupted or deleted from the system.

1. From the Start screen, type `HP Software Setup`, and select **Apps**.
2. Open HP Software Setup.
3. Follow the on-screen directions to reinstall drivers or select software.

# Windows 7

To protect your information, use Windows Backup and Restore to back up individual files and folders, back up your entire hard drive (select models only), create system repair discs (select models only) with the installed optical drive (select models only) or an optional external optical drive, or create system restore points. In case of system failure, you can use the backup files to restore the contents of your computer.

Windows Backup and Restore provides the following options:

- Creating a system repair disc (select models only) by using the installed optical drive (select models only) or an optional external optical drive
- Backing up your information
- Creating a system image (select models only)
- Scheduling automatic backups (select models only)
- Creating system restore points
- Recovering individual files
- Restoring the computer to a previous state
- Information using recovery tools

---

 **NOTE:** For detailed instructions, perform a search for these topics in Help and Support.

In case of system instability, HP recommends that you print the recovery procedures and save them for later use.

 **NOTE:** Windows includes the User Account Control feature to improve the security of your computer. You may be prompted for your permission or password for tasks such as installing software, running utilities, or changing Windows settings. See Help and Support for more information.

---

## Creating recovery media with HP Recovery Disc Creator

 **NOTE:** Your computer may not come equipped with an internal optical drive. In order to create the recovery DVD, you may need to plug in an external optical drive.

---

HP Recovery Disc Creator is a software program that offers an alternative way to create recovery media. After you successfully set up the computer, you can create recovery media using HP Recovery Disc Creator. This recovery media performs a system recovery if the hard drive becomes corrupted. A system recovery reinstalls the original operating system and the software programs installed at the factory, and then configures the settings for the programs.

HP Recovery Disc Creator can create two kinds of recovery DVDs as follows:

- **Windows DVD**—Installs the operating system without additional drivers or applications. Choosing this selection creates a DVD that restores the original operating system and the software programs installed at the factory.
- **Driver DVD**—Installs specific drivers and applications only, in the same way that the HP Software Setup utility installs drivers and applications.

## Creating recovery media

 **NOTE:** Operating system recovery media can be created only once. Thereafter, the option to create that media will not be available.

---

1. Select **Start > All Programs > Security and Protection > HP Recovery Disc Creator**.
2. Select **Driver DVD or Windows DVD**.
3. From the drop-down menu, select the drive for burning the recovery media.
4. Click the **Burn** button to start the burning process.

## Backing up your information

Recovery after a system failure is as good as your most recent backup. Immediately after software setup, you should create system repair discs (select models only) using HP Recovery Disc Creator using the installed optical drive (select models only) or an optional external optical drive and back up your system. As you add new software and data files, you should continue to back up your system on a regular basis to maintain a reasonably current backup. The system repair discs (select models only) are used to start up (boot) the computer and repair the operating system in case of system instability or failure. Your initial and subsequent backups allow you to restore your data and settings if a failure occurs.

You can back up your information to an optional external hard drive, a network drive, or discs.

Note the following when backing up:

- Store personal files in the Documents library, and back it up regularly.
- Back up templates that are stored in their associated programs.
- Save customized settings that appear in a window, toolbar, or menu bar by taking a screen shot of your settings. The screen shot can be a time-saver if you have to reset your preferences.

- When backing up to discs, use any of the following types of discs (purchased separately): CD-R, CD-RW, DVD+R, DVD+R DL, DVD-R, DVD-R DL, or DVD±RW. The discs you use will depend on the type of optical drive you are using.

---

 **NOTE:** Your computer may not come equipped with an internal optical drive. In order to create back up discs, you may need to plug in an external optical drive.

 **NOTE:** DVDs and DVDs with double-layer (DL) support store more information than CDs, so using them for backup reduces the number of recovery discs required.

---

- When backing up to discs, number each disc before inserting it into the external drive.

To create a backup using Backup and Restore:

---

 **NOTE:** Be sure that the computer is connected to AC power before you start the backup process.

 **NOTE:** The backup process may take over an hour, depending on file size and the speed of the computer.

---

1. Select **Start > All Programs > Maintenance > Backup and Restore**.
2. Follow the on-screen instructions to set up your backup, create a system image (select models only), or create a system repair disc (select models only).

## Performing a system recovery

In case of system failure or instability, the computer provides the following tools to recover your files:

- Windows recovery tools: You can use Windows Backup and Restore to recover information you have previously backed up. You can also use Windows Startup Repair to fix problems that might prevent Windows from starting correctly.
- f11 recovery tools: You can use the **f11** recovery tools to recover your original hard drive image. The image includes the Windows operating system and software programs installed at the factory.

---

 **NOTE:** If you are unable to boot (start up) your computer and you cannot use the system repair discs you previously created (select models only), you must purchase a Windows 7 operating system DVD to reboot the computer and repair the operating system. For additional information, see [Using a Windows 7 operating system DVD \(purchased separately\) on page 160](#).

 **NOTE:** Your computer may not come equipped with an internal optical drive. In order to use the operating system DVD, you may need to plug in an external optical drive.

---

## Using the Windows recovery tools

To recover information you previously backed up:

1. Select **Start > All Programs > Maintenance > Backup and Restore**.
2. Follow the on-screen instructions to recover your system settings, your computer (select models only), or your files.

To recover your information using Startup Repair, follow these steps:

---

 **CAUTION:** Using Startup Repair completely erases hard drive contents and reformats the hard drive. All files you have created and any software installed on the computer are permanently removed. When reformatting is complete, the recovery process restores the operating system, as well as the drivers, software, and utilities from the backup used for recovery.

---

1. If possible, back up all personal files.
2. If possible, check for the presence of the Windows partition and the HP Recovery partition.

To check for the Windows partition, select **Start > Computer**.

To check for the HP Recovery partition, click **Start**, right-click **Computer**, click **Manage**, and then click **Disk Management**.

---

 **NOTE:** If the HP Recovery partition has been deleted, the **f11** restore option will not function. You must recover your operating system and programs using the Windows 7 operating system DVD and the Driver Recovery disc (both purchased separately) if the Windows partition and the HP Recovery partition are not listed. For additional information, see [Using a Windows 7 operating system DVD \(purchased separately\) on page 160](#).

---

3. If the Windows partition and the HP Recovery partition are listed, restart the computer, and then press **f8** before the Windows operating system loads.
4. Select **Startup Repair**.
5. Follow the on-screen instructions.

---

 **NOTE:** For additional information on recovering information using the Windows tools, perform a search for these topics in Help and Support.

---



## Using f11 recovery tools

 **CAUTION:** Using f11 recovery tools completely erases hard drive contents and reformats the hard drive. All files you have created and any software installed on the computer are permanently removed. The f11 recovery tool reinstalls the operating system and HP programs and drivers that were installed at the factory. Software not installed at the factory must be reinstalled.

---

To recover the original hard drive image using f11:

1. If possible, back up all personal files.
2. If possible, check for the presence of the HP Recovery partition: click **Start**, right-click **Computer**, click **Manage**, and then click **Disk Management**.

 **NOTE:** If the HP Recovery partition is not listed, you must recover your operating system and programs using the Windows 7 operating system DVD and the Driver Recovery disc (both purchased separately). For additional information, see [Using a Windows 7 operating system DVD \(purchased separately\) on page 160](#).

---

 **NOTE:** Your computer may not come equipped with an internal optical drive. In order to use the operating system DVD, you may need to plug in an external optical drive.

---

3. If the HP Recovery partition is listed, restart the computer, and then press **esc** while the “Press the ESC key for Startup Menu” message is displayed at the bottom of the screen.
4. Press f11 while the “Press <F11> for recovery” message is displayed on the screen.
5. Follow the on-screen instructions.

## Using a Windows 7 operating system DVD (purchased separately)

To order a Windows 7 operating system DVD, go to the HP website. For U.S. support, go to <http://www.hp.com/go/contactHP>. For worldwide support, go to [http://welcome.hp.com/country/us/en/wwcontact\\_us.html](http://welcome.hp.com/country/us/en/wwcontact_us.html). You can also order the DVD by calling support. For contact information, see the *Worldwide Telephone Numbers* booklet included with the computer.

---

 **CAUTION:** Using a Windows 7 operating system DVD completely erases hard drive contents and reformats the hard drive. All files you have created and any software installed on the computer are permanently removed. When reformatting is complete, the recovery process helps you restore the operating system, as well as drivers, software, and utilities.

---

To initiate recovery using a Windows 7 operating system DVD:

 **NOTE:** This process takes several minutes.

 **NOTE:** Your computer may not come equipped with an internal optical drive. In order to use the operating system DVD, you may need to plug in an external optical drive.

---

1. If possible, back up all personal files.
2. Restart the computer, and then insert the Windows 7 operating system DVD into the optical drive before the Windows operating system loads.
3. When prompted, press any keyboard key.
4. Follow the on-screen instructions.
5. Click **Next**.
6. Select **Repair your computer**.
7. Follow the on-screen instructions.

After the repair is completed:

1. Eject the Windows 7 operating system DVD, and then insert the *Driver Recovery* disc.
2. Install the Hardware Enabling Drivers first, and then install Recommended Applications.

# Linux

Recovery after a system failure is as good as your most recent backup. As you add new software and data files, you should continue to back up your system on a regular basis to maintain a reasonably current backup.

Your computer includes tools provided by HP to help you safeguard your information and retrieve it if ever needed.

## Creating backups

1. Create restore media immediately after you set up the computer. For more information, see [Performing a system recovery on page 162](#).
2. As you add files, routinely create a backup of your system and personal information.

## Backing up your information

You should back up your computer files on a regular schedule to maintain a current backup. You can manually back up your information to an optional external drive, a network drive, or discs. Back up your system at the following times:

- At regularly scheduled times
- Before the computer is repaired or restored
- Before you add or modify hardware or software

To back up your home directory files using **Backup Manager Settings**:

1. Select **Computer > More Applications > Tools > Backup Manager Settings**, and click **Backup my home directory**.
2. Click **Storage Destination Location**, and then select a location to back up your information.
3. Click **Schedule**, and then select a time schedule to perform backups at a regularly scheduled time.

To immediately back up your information, click the **Backup Now** check box.



**NOTE:** Before you back up your information, be sure you have designated a location to save the backup files.

4. Click **Save and Backup** to start the backup and to save the backup settings.

To restore backup files:

1. Select **Computer > More Applications > Tools > Backup Manager Restore**.
2. Click **Backup Source**, and then select the location of the backup files.
3. Click **Restore Destination**, and then select the destination to restore the files.

4. To restore all files from the selected location, click **Restore all files**. To restore select files only, click **Restore selected files**, click **Select Files** and then select the files to be restored.
5. Under **Restore Point**, click the time and date of the backup.

---

 **NOTE:** If multiple backups have been performed, click Use the latest version to restore the latest version.

---

6. Click **Restore** to start restoring the files, or click **Cancel** to cancel the operation.

## Performing a system recovery

Recovery allows you to repair or restore the computer to its original factory state. You can create an HP Factory Image, using an installed or an external DVD±RW optical drive.

---

 **NOTE:** Your computer may not come equipped with an internal optical drive. In order to create the HP Factory Image, you may need to plug in an external optical drive.

---

 **CAUTION:** Using Recovery completely erases hard drive contents and reformats the hard drive. All files you have created and any software installed on the computer are permanently removed. The recovery tool reinstalls the original operating system and HP programs and drivers that were installed at the factory. Software, drivers, and updates not installed by HP must be manually reinstalled. Personal files must be restored from a backup.

---

To restore the computer using the HP Factory Image, you must first create the recovery ISO file and then burn it to an optical disc.

---

 **NOTE:** HP recommends that you create the HP Factory Image in the event of a system failure.

---

1. Select **Computer > More Applications**.
2. In the left pane, click **Tools**, and then click **Create HP Factory Image** in the right pane.
3. Enter the root password when prompted.
4. Right-click on the HP\_Recovery.iso file and select **Open with Brasero**.
5. Insert a blank DVD disc and select **Burn**. This creates the HP Factory Image Restore DVD.

To restore the computer from the recovery disc, follow these steps:

1. If possible, back up all personal files.
2. Insert the HP Factory Image Restore DVD into the optical drive and restart the computer.
3. As the computer is restarting, press **f9** to open the Computer Setup boot option menu.
4. Select **Optical Disk Drive** from the Boot Options menu and press **enter**.
5. Press **enter** to select **Restore System from Media**.
6. At both of the System Recovery prompts, select **Yes**.

## Remove everything and reinstall SLED

Sometimes you want to perform detailed reformatting of your computer, or you want to remove personal information before you give away or recycle your computer. The process described in this section provides a speedy, simple way to return the computer to its original state. This option removes all personal data, applications, and settings from your computer, and reinstalls the Linux operating system.



---

**IMPORTANT:** This option does not provide backups of your information. Before using this option, back up any personal information you wish to retain.

---

You can initiate this option by using the **f11** key.

To use the **f11** key:

Press **f11** while the computer boots.

– or –

Press and hold **f11** as you press the power button.

To reinstall SLED, follow the steps below.

1. Select **System Recovery** from the boot menu after pressing **f11**.
2. A prompt will appear, reading, “This utility will wipe out your hard drive contents and restore your PC to factory state. Are you sure you want to continue?” Select **Yes**.
3. A prompt will appear, reading, “Please confirm you want to restore your system to factory state and lose all your current data.” Select **Yes**.



---

# 10 Statement of Volatility

The purpose of this document is to provide general information regarding non-volatile memory in industry-standards based HP Business Notebook PC systems and provide general instructions for restoring nonvolatile memory that can contain personal data after the system has been powered off and the hard drive has been removed.

HP Business Notebook PC products that use Intel-based or AMD®-based system boards contain volatile DDR memory. The amount of nonvolatile memory present in the system depends upon the system configuration. Intel-based and AMD-based system boards contain nonvolatile memory subcomponents as originally shipped from HP assuming that no subsequent modifications have been made to the system and assuming that no applications, features, or functionality have been added to or installed on the system.

Following system shutdown and removal of all power sources from an HP Business Notebook PC system, personal data can remain on volatile system memory (DIMMs) for a finite period of time and will also remain in nonvolatile memory. The steps below will remove personal data from the notebook PC, including the nonvolatile memory found in Intel-based and AMD-based system boards. Some of these steps are disclosed in the Maintenance and Service Guides available for HP PC products available on the product support pages at [www.hp.com](http://www.hp.com).

1. Follow steps (a) through (l) below to restore the nonvolatile memory that can contain personal data. Restoring or re-programming nonvolatile memory that does not store personal data is neither necessary nor recommended.
  - a. Enter BIOS (F10) Setup by powering on the system and pressing **F10** when prompted near the bottom of the display, or press the **ESC** key to display the start up menu, then press **F10** . If the system has a BIOS administrator password, enter the password at the prompt.
  - b. Select the **Main** menu, then **Restore Defaults**.
  - c. Select the **System Configuration** menu, then **Restore Security Defaults**.
  - d. If an asset or ownership tag is set, select the **Security** menu and scroll down to the **Utilities** menu. Select **System IDs**, and then select the tag that has been set. Press the spacebar once to clear the tag, then press **Enter** to return to the prior menu.
  - e. If a DriveLock password is set, select the **Security** menu, scroll down to **DriveLock**, then select **DriveLock password**. Select the desired hard drive. Click **Disable protection**, enter the existing master DriveLock password, then press **Enter** to confirm and return to the prior menu. Repeat this procedure if more than one hard drive has a DriveLock password.

- f. If an Automatic DriveLock password is set, select the **Security menu**, scroll down to **Automatic DriveLock**, then select the desired hard drive and disable protection. Repeat this procedure if more than one hard drive has an Automatic DriveLock password.
- g. Select the **File** menu, then **Reset BIOS Security** to factory default. Click **yes** at the warning message.
- h. Select the **Main** menu, then **Save Changes and Exit**.
- i. Reboot the system. If the system has a Trusted Platform Module and/or fingerprint sensor, one or two prompts will appear: one to clear the TPM and the other to reset fingerprint sensor. Press **F1** to accept or **F2** to reject.

If the HP notebook model number ends in a 'p' or 'w' and includes Intel Centrino with VPro™, reboot the PC and enter BIOS Setup by pressing **F10** when prompted. Select **System Configuration**, then **AMT Options**. Then select **Un-configure AMT on next boot**. Select **Save**, then **Yes**. Select the **File** menu, and then select **Save Changes and Exit**. Reboot the system and confirm that you want to un-configure AMT.

- j. If the optional Intel Anti-Theft Technology (AT) was activated, contact the provider to deactivate it.
- k. If the optional Absolute® Software Computrace® management and tracking service was activated on the notebook PC, contact the provider to deactivate it.
- l. Remove all power and system batteries for at least 24 hours.

## 2. Remove and retain the storage drive or clear the contents of the drive.

### a. Hard Disk Drive (HDD)

Clear the HDD contents by using the HP Disk Sanitizer® utility or a third party application that, ideally, is U.S. Department of Defense (DOD) 5220.22-M approved.

To run HP Disk Sanitizer, enter BIOS Setup by powering on the system and pressing **F10** when prompted near the bottom of the display, or press **ESC** to display the start up menu, then press **F10**. Select the **Security** menu and scroll down to the **Utilities** menu. Select **Disk Sanitizer** and select the desired drive. For a higher level of protection, select **Optimum**.

---

 **NOTE:** This process will take a long time, and the amount of time varies based on the hard drive capacity.

---

### b. Solid State Drive (SSD)

Clear the SSD contents by using the BIOS Setup Secure Erase command option, or by using a third party utility designed to erase data from an SSD. To run Secure Erase, enter BIOS Setup by powering on the system and pressing **F10** when prompted near the bottom of the display. Select the **Security** menu and scroll down to the **Utilities** menu. Select **Secure Erase** and select the desired hard drive.



# Non-volatile memory usage

Non Volatile Memory Type	Amount (Size)	Does this memory store customer data?	Does this memory retain data when power is removed?	What is the purpose of this memory?	How is data input into this memory?	How is this memory write protected?
HP Sure Start flash (select models only)	2 MB	No	Yes	Provides protected backup of critical System BIOS code, EC firmware, and critical PC configuration data for select platforms that support HP Sure Start.  For more information, see <a href="#">Using HP Sure Start (select models only) on page 172</a> .	Data cannot be written to this device via the host processor. The content is managed solely by the HP Sure Start Embedded Controller.	This memory is protected by the HP Sure Start Embedded Controller.
Real Time Clock (RTC) battery backed-up CMOS configuration memory (CMOS)	256 Bytes	No	Yes	Stores system date and time and limited keyboard controller data.	Using the <b>F10</b> Setup utility or changing the Microsoft Windows date and time.	This memory is not write-protected. HP recommends password protecting the <b>F10</b> Setup utility.
Controller (NIC) EEPROM	64 KBytes (not customer accessible)	No	Yes	Store NIC configuration and NIC firmware.	Using a utility from the NIC vendor that can be run from DOS.	A utility is required to write data to this memory and is available from NIC vendor. Writing data to this ROM in an inappropriate manner will render the NIC nonfunctional.

<b>Non Volatile Memory Type</b>	<b>Amount (Size)</b>	<b>Does this memory store customer data?</b>	<b>Does this memory retain data when power is removed?</b>	<b>What is the purpose of this memory?</b>	<b>How is data input into this memory?</b>	<b>How is this memory write protected?</b>
Keyboard ROM	64 KBytes (not customer accessible)	No	Yes	Stores firmware code (keyboard, mouse, & battery management).	Programmed at the factory. Code is updated when the system BIOS is updated.	A utility is required for writing data to this memory and is available on the HP website. Writing data to this ROM in an inappropriate manner can render the PC nonfunctional.
DIMM Serial Presence Detect (SPD) configuration data	256 Bytes per memory module, 128 Bytes programmable (not customer accessible)	No	Yes	Stores memory module information.	Programmed by the memory vendor.	Data cannot be written to this memory when the module is installed in a PC. The specific write protection method varies by memory vendor.
System BIOS	4 to 5 MBytes	Yes	Yes	Store system BIOS code and PC configuration data.	System BIOS code is programmed at the factory. Code is updated when the system BIOS is updated. Configuration data and settings are input using the <a href="#">F10</a> setup utility or a custom utility.	A utility is required for writing data to this memory and is available on the HP website. Writing data to this ROM in an inappropriate manner can render the PC nonfunctional.

<b>Non Volatile Memory Type</b>	<b>Amount (Size)</b>	<b>Does this memory store customer data?</b>	<b>Does this memory retain data when power is removed?</b>	<b>What is the purpose of this memory?</b>	<b>How is data input into this memory?</b>	<b>How is this memory write protected?</b>
Intel Management Engine Firmware (present only in specific ZBook and EliteBook models. For more information, go to <a href="http://www.hp.com/support">http://www.hp.com/support</a> , and select your country. Select <b>Drivers &amp; Downloads</b> , and then follow the on-screen instructions.)	1.5 or 5 MBytes	Yes	Yes	Stores Management Engine Code, Settings, Provisioning Data and iAMT third party data store.	Management Engine Code is programmed at the factory. Code is updated via Intel secure firmware update utility. Unique Provisioning Data can be entered at the factory or by an administrator using the Management Engine (MEBx) setup utility. The third party data store contents can be populated by a remote management console or local applications registered by an administrator to have access to the space.	The Intel chipset is configured to enforce hardware protection to block all direct read/write access to this area. An Intel utility is required for updating the firmware. Only firmware updates digitally signed by Intel can be applied using this utility.
Bluetooth flash	2 MBits	No	Yes	Stores Bluetooth configuration and firmware.	Programmed at the factory. Tools for writing data to this memory are not publicly available but can be obtained from the silicon vendor.	A utility is required for writing data to this memory and is made available through newer versions of the driver if the flash requires an upgrade.

<b>Non Volatile Memory Type</b>	<b>Amount (Size)</b>	<b>Does this memory store customer data?</b>	<b>Does this memory retain data when power is removed?</b>	<b>What is the purpose of this memory?</b>	<b>How is data input into this memory?</b>	<b>How is this memory write protected?</b>
802.11 WLAN EEPROM	4 KBytes to 8 KBytes	No	Yes	Stores configuration and calibration data.	Programmed at the factory. Tools for writing data to this memory are not made public.	A utility is required for writing data to this memory and is typically not made available to the public unless a firmware upgrade is necessary to address a unique issue.
Webcam	64 KBits	No	Yes	Store webcam configuration and firmware.	Using a utility from the device manufacturer that can be run from Windows.	A utility is required for writing data to this memory and is typically not made available to the public unless a firmware upgrade is necessary to address a unique issue.
Fingerprint reader	512 KBytes flash	Yes	Yes	Stores fingerprint templates.	By enrolling in HP ProtectTools Security Manager.	Only a digitally signed application can make the call to write to the flash.

# Questions and answers

**1. How can the BIOS settings be restored (returned to default settings)?**

- a. Turn on or restart the computer and press **F10** when prompted near the bottom of the display.
- b. Select **File**, then select **Restore defaults**.
- c. Follow the on-screen instructions.
- d. Select **File**, save changes and exit, then press **Enter**.

**2. What kind of configuration data is stored on the DIMM Serial Presence Detect (SPD) memory module? How would this data be written?**

The DIMM SPD memory contains information about the memory module such as size, serial number, data width, speed/timing, voltage and thermal information. This information is written by the module manufacturer and stored on an EEPROM. This EEPROM cannot be written to when the memory module is installed in a PC. Third party tools do exist that can write to the EEPROM when the memory module is not installed in a PC. There are various third party tools available to read SPD memory.

**3. Does the “Firmware Hub for System BIOS” contain the BIOS program? Is this chip writable, and if so how?**

The Firmware Hub does contain the BIOS program and is writable. A utility is required to perform the write function.

**4. In some PC systems, the Firmware Hub for System BIOS is a flash memory chip so that updates can be written by the customer. Is this true for these BIOS chips?**

Yes, they are flash memory chips.

**5. What is meant by “Restore the nonvolatile memory found in Intel-based system boards?”**

This relates to clearing the Real Time Clock (RTC) CMOS memory that contains PC configuration data.

**6. Does resetting the CMOS configuration memory return the PC back to factory defaults?**

The process of resetting the CMOS will return certain system settings to factory default but will not reset many of the system data and configuration defaults to their default settings. To return these system data and configuration defaults to default settings, refer to question and answer 1 and follow the instructions for returning the BIOS settings to factory defaults.

## Using HP Sure Start (select models only)

Select computer models are configured with HP Sure Start, a technology that continuously monitors your computer's BIOS for attacks or corruption. If the BIOS becomes corrupted or is attacked, HP Sure Start restores the BIOS to its previously safe state automatically, with user intervention. Those select computer models ship with HP Sure Start configured and enabled. Most users can use HP Sure Start with the default configuration.

To access the latest documentation on HP Sure Start, go to <http://www.hp.com/support>, and select your country. Select **Driver & and Downloads**, and then follow the on-screen instructions.

# 11 Power cord set requirements

The wide-range input feature of the computer permits it to operate from any line voltage from 100 to 120 volts AC, or from 220 to 240 volts AC.

The 3-conductor power cord set included with the computer meets the requirements for use in the country or region where the equipment is purchased.

Power cord sets for use in other countries and regions must meet the requirements of the country or region where the computer is used.

## Requirements for all countries

The following requirements are applicable to all countries and regions:

- The length of the power cord set must be at least 1.0 m (3.3 ft) and no more than 2.0 m (6.5 ft).
  - All power cord sets must be approved by an acceptable accredited agency responsible for evaluation in the country or region where the power cord set will be used.
  - The power cord sets must have a minimum current capacity of 10 amps and a nominal voltage rating of 125 or 250 V AC, as required by the power system of each country or region.
  - The appliance coupler must meet the mechanical configuration of an EN 60 320/IEC 320 Standard Sheet C13 connector for mating with the appliance inlet on the back of the computer.
- Requirements for all countries 113

## Requirements for specific countries and regions

Country/region	Accredited agency	Applicable note number
Australia	EANSW	1
Austria	OVE	1
Belgium	CEBC	1
Canada	CSA	2
Denmark	DEMKO	1
Finland	FIMKO	1

Country/region	Accredited agency	Applicable note number
France	UTE	1
Germany	VDE	1
Italy	IMQ	1
Japan	METI	3
The Netherlands	KEMA	1
Norway	NEMKO	1
The People's Republic of China	COC	5
South Korea	EK	4
Sweden	CEMKO	1
Switzerland	SEV	1
Taiwan	BSMI	4
The United Kingdom	BSI	1
The United States	UL	2

1. The flexible cord must be Type HO5VV-F, 3-conductor, 1.0-mm<sup>2</sup> conductor size. Power cord set fittings (appliance coupler and wall plug) must bear the certification mark of the agency responsible for evaluation in the country or region where it will be used.
2. The flexible cord must be Type SPT-3 or equivalent, No. 18 AWG, 3-conductor. The wall plug must be a two-pole grounding type with a NEMA 5-15P (15 A, 125 V) or NEMA 6-15P (15 A, 250 V) configuration.
3. The appliance coupler, flexible cord, and wall plug must bear a "T" mark and registration number in accordance with the Japanese Dentori Law. The flexible cord must be Type VCT or VCTF, 3-conductor, 1.00-mm<sup>2</sup> conductor size. The wall plug must be a two-pole grounding type with a Japanese Industrial Standard C8303 (7 A, 125 V) configuration.
4. The flexible cord must be Type RVV, 3-conductor, 0.75-mm<sup>2</sup> conductor size. Power cord set fittings (appliance coupler and wall plug) must bear the certification mark of the agency responsible for evaluation in the country or region where it will be used.
5. The flexible cord must be Type VCTF, 3-conductor, 0.75-mm<sup>2</sup> conductor size. Power cord set fittings (appliance coupler and wall plug) must bear the certification mark of the agency responsible for evaluation in the country or region where it will be used.



---

# 12 Recycling

When a non-rechargeable or rechargeable battery has reached the end of its useful life, do not dispose of the battery in general household waste. Follow the local laws and regulations in your area for battery disposal.

HP encourages customers to recycle used electronic hardware, HP original print cartridges, and rechargeable batteries. For more information about recycling programs, see the HP Web site at <http://www.hp.com/recycle>.



---

# Index

## A

AC adapter light 23  
AC adapter, spare part numbers 45, 49, 50, 55, 56  
antenna  
  location 17  
  removal 104, 105  
  spare part numbers 42, 55, 60, 64, 105  
Antenna Kit, spare part numbers 42, 55, 60, 105  
audio, product description 6  
audio-in jack 25  
audio-out jack 25

## B

base enclosure, spare part numbers 38, 54, 58  
battery  
  removal 73  
  spare part numbers 38, 49, 73  
battery light 23  
bottom components 26  
button components 19  
buttons  
  pointing stick 22  
  power 19  
  TouchPad 22  
  TouchPad on/off 22  
  volume mute 19  
  wireless 19

## C

cables, service considerations 66  
caps lock light 21

card reader board  
  removal 108  
  spare part number 34, 55, 108  
carrying case, spare part numbers 46, 48, 49, 50  
chipset, product description 1  
components  
  bottom 26  
  buttons 19  
  display 17  
  fingerprint reader 19  
  front 23  
  keys 20  
  left side 24  
  lights 21  
  right side 25  
  TouchPad 22  
computer  
  major components 29  
  specifications 147  
connectors, service considerations 66

## D

DC cable, spare part number 46, 48  
display assembly  
  removal 98  
  spare part numbers 30, 41, 58, 98  
display bezel  
  removal 100  
  spare part numbers 41, 53, 59, 60, 100  
display components 17  
display enclosure, spare part numbers 42, 55, 60

Display Hinge Kit, spare part numbers 42, 53, 60, 104  
display panel  
  product description 3  
  removal 101  
  spare part numbers 42, 50, 58, 63, 102  
display panel cable  
  removal 103  
  spare part number 42, 50, 103  
Display Panel Support Kit, spare part numbers 42, 50, 60  
DisplayPort 25  
DisplayPort-to-HDMI cable, spare part number 46, 48  
docking port 25  
docking station, spare part number 46, 55  
docking, product description 9  
drives, preventing damage 66

## E

electrostatic discharge 67  
embedded numeric keypad 20  
equipment guidelines 69  
esc key 20  
Ethernet, product description 7  
external expansion, product description 8  
external VGA monitor port 24

## F

fan  
  removal 113  
  spare part numbers 38, 53, 64, 113

- fingerprint reader
    - component 19
    - location 19
  - fingerprint reader board
    - removal 121
    - spare part number 34, 54, 121
  - flash cache, product description 4
  - fn key 20
  - front components 23
  - function keys 20
- G**
- graphics, product description 3
  - grounding guidelines 67
  - guidelines
    - equipment 69
    - grounding 67
    - packaging 68
    - transporting 68
    - workstation 68
- H**
- hard drive
    - precautions 66
    - product description 5
    - removal 75
    - spare part numbers 38, 44, 48, 49, 55, 58, 63, 75
  - hard drive bracket
    - illustrated 45
    - removal 76
  - hard drive connector adapter
    - illustrated 45
    - removal 77
  - Hard Drive Hardware Kit
    - contents 45
    - spare part number 45, 50
  - hard drive light 23
  - headphone jack 25
  - heat sink
    - removal 111
    - spare part numbers 38, 54, 58, 111
  - hinge
    - removal 104
    - spare part numbers 42, 53, 60, 104
- HP DisplayPort-to-HDMI 1.4 adapter, spare part number 46, 56
- I**
- internal display switch 18
- J**
- jacks
    - audio-in 25
    - audio-out 25
    - headphone 25
    - microphone 25
    - network 25
    - RJ-45 25
- K**
- key components 20
  - keyboard
    - product description 9
    - removal 85
    - spare part numbers 30, 31, 32, 33, 50, 51, 52, 53, 60, 61, 62, 63, 85
  - keys
    - esc 20
    - fn 20
    - function 20
    - num lk 20
    - Windows logo 20
- L**
- left-side components 24
  - light components 21
  - lights
    - AC adapter 23
    - battery 23
    - caps lock 21
    - hard drive 23
    - microphone mute 21
    - mute 21
    - num lock 21
    - power 21, 23
    - webcam 17
    - wireless 21, 23
  - lock, spare part numbers 46, 48, 49
  - LTE antenna, spare part number 64
- M**
- mass storage devices
    - illustrated 44
    - precautions 66
    - spare part numbers 44
  - memory card reader 25
  - memory module
    - product description 4
    - removal 84
    - spare part numbers 39, 49, 84
  - microphone
    - location 17
    - product description 6
  - microphone jack 25
  - microphone module
    - removal 102
    - spare part number 42, 55, 103
  - microphone mute light 21
  - MiniCard solid-state drive, product description 4
  - model name 1
  - mouse, spare part numbers 46, 48, 49
  - mute light 21
- N**
- network jack 25
  - num lk key 20
  - num lock light 21
  - numeric keypad 20
- O**
- operating system, product description 11
- P**
- packaging guidelines 68
  - plastic parts, service considerations 65
  - Plastics Kit
    - components 43
    - spare part number 43, 55
  - pointing device, product description 9
  - pointing stick 22
  - pointing stick button 22
  - ports
    - DisplayPort 25
    - docking 25

- external VGA monitor 24
  - product description 9
  - USB 3.0 25
  - USB 3.0 charging 24
- power button 19
- power button board
  - removal 124
  - spare part number 34, 54, 124
- power connector 25
- power cord
  - set requirements 173
  - spare part numbers 46, 47, 48, 56, 57, 58
- power light 21, 23
- power requirements, product description 10
- processor, product description 2
- product description
  - audio 6
  - chipset 1
  - display panel 3
  - docking 9
  - Ethernet 7
  - external expansion 8
  - flash cache 4
  - graphics 3
  - hard drive 5
  - keyboard 9
  - memory module 4
  - microphone 6
  - MiniCard solid-state drive 4
  - operating system 11
  - pointing device 9
  - ports 9
  - power requirements 10
  - primary storage 5
  - processor 2
  - product name 1
  - security 10
  - serviceability 15
  - solid-state drive 5
  - video 6
  - wireless networking 7
- product name 1

**R**

- removal/replacement
  - procedures 71, 93
- right-side components 25

- RJ-45 jack 25
- RTC battery
  - removal 93
  - spare part number 34, 49, 93
- Rubber Kit, spare part number 38, 53

**S**

- Screw Kit, spare part number 47, 54
- security cable slot 24
- security, product description 10
- service considerations
  - cables 66
  - connectors 66
  - plastic parts 65
- service cover
  - location 26
  - removal 71
  - spare part numbers 40, 55, 56, 58, 59, 71
- service cover release latch 26
- serviceability, product description 15
- SIM, spare part number 46, 49
- smart card reader 24
- solid-state drive
  - precautions 66
  - product description 5
  - removal 80
  - spare part numbers 39, 45, 55, 56, 58, 59, 63, 80
- speaker assembly
  - removal 122
  - spare part number 34, 54, 122
- speakers, location 19
- specifications 147
- system board
  - removal 115
  - spare part numbers 34, 54, 55, 56, 57, 58, 59, 63, 64, 115

**T**

- tools required 65
- top cover
  - removal 94
  - spare part numbers 34, 53, 64, 94

- TouchPad
  - removal 107
  - spare part number 37, 53, 107
- TouchPad button 22
- TouchPad components 22
- TouchPad on/off button 22
- TouchPad zone 22
- transporting guidelines 68

**U**

- USB 3.0 charging port 24
- USB 3.0 port 25
- USB 3.0 port replicator, spare part number 47, 49
- USB 3.0 type A connector to type B connector cable, spare part number 49

**V**

- vents 24, 26
- video, product description 6
- volume mute button 19

**W**

- webcam light 17
- webcam, location 18
- webcam/microphone module
  - removal 102
  - spare part numbers 42, 53, 64, 103
- Windows logo key 20
- wireless antenna
  - location 17
  - removal 104, 105
  - spare part numbers 42, 55, 60, 105
- wireless button 19
- wireless light 21, 23
- wireless networking, product description 7
- WLAN module
  - removal 82
  - spare part numbers 39, 48, 49, 50, 55, 56, 82
- workstation guidelines 68
- WWAN module
  - removal 78
  - spare part numbers 38, 49, 50, 56, 78





